

22195

# AIRPORT DIAGRAM

EASTERN WV RGNL/SHEPHERD FLD (MR.B)

AL-249 (FAA)

MARTINSBURG, WEST VIRGINIA

ASOS  
 119.925  
 MARTINSBURG TOWER ★  
 124.3 233.7  
 GND CON  
 121.8 257.65  
 CLNC DEL  
 121.8 257.65  
 132.075 269.075 (When Tower Closed)

39°25.0'N

D

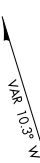

JANUARY 2020  
 ANNUAL RATE OF CHANGE  
 0.0° E

NE HANGARS

39°24.5'N

NE-4, 22 FEB 2024 to 21 MAR 2024

WEST VIRGINIA ANG  
 FIRE STATION  
 TWR

ELEV 550

8815 X 150

261.0°

39°24.0'N

FBO TERMINAL

MRB EAST

FIELD  
 ELEV  
 565

080.9°

MRB WEST

MRB SOUTH

RWY 08-26

PCN 56 R/B/W/T  
 S-120, D-195, 2D-339,  
 2D/2D2-830

39°23.5'N

704

CAUTION: BE ALERT TO RUNWAY CROSSING CLEARANCES.  
 READBACK OF ALL RUNWAY HOLDING INSTRUCTIONS IS REQUIRED.

77°59.5'W

77°59.0'W

77°58.5'W

NE-4, 22 FEB 2024 to 21 MAR 2024

# AIRPORT DIAGRAM

22195

MARTINSBURG, WEST VIRGINIA

EASTERN WV RGNL/SHEPHERD FLD (MR.B)

**TOP ALTITUDE:  
3000**

ASOS  
119.925  
CLINC DEL  
121.8 257.65  
132.075 269.075 (When twr closed)  
GND CON  
121.8 257.65  
MARTINSBURG TOWER \*  
124.3 (CTAF) 233.7  
POTOMAC DEP CON  
126.825 239.025

**DEPARTURE ROUTE DESCRIPTION**

Climb on heading assigned by ATC, expect RADAR vectors to BUTRZ, then on track 239° to CLTCH, thence . . .

. . . on assigned transition, maintain altitude assigned by ATC, expect clearance to filed altitude within ten (10) minutes after departure.

FLASK TRANSITION (CLTCH3.FLASK)  
MAULS TRANSITION (CLTCH3.MAULS)

- NOTE: RNAV 1.
- NOTE: RADAR required.
- NOTE: DME/DME/IRU or GPS required.
- NOTE: Turbo-jets only.
- NOTE: Takeoff Rwy 8: If issued an ATC heading that requires a westbound turn, climb heading 081° to 1200 prior to turning for obstacle avoidance.
- NOTE: Takeoff Rwy 26: If issued an ATC heading that requires a right turn, climb heading 261° to 2400 prior to turning for obstacle avoidance.

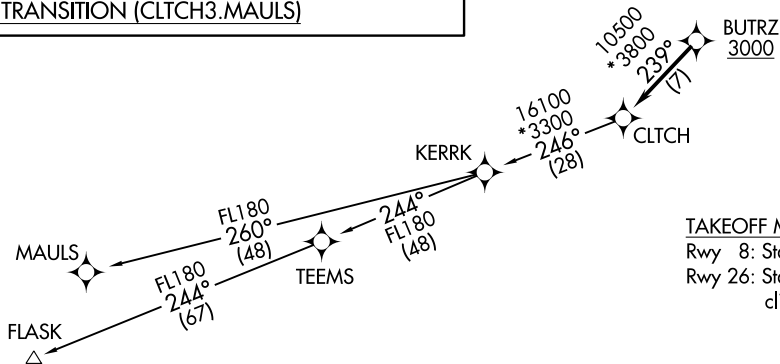

TAKEOFF MINIMUMS

Rwy 8: Standard.  
Rwy 26: Standard with a minimum climb of 225' per NM to 2100.

NOTE: Chart not to scale.

CLTCH THREE DEPARTURE (RNAV)  
(CLTCH3:CLTCH) 31DECCO

MARTINSBURG, WEST VIRGINIA  
EASTERN WV RGNL/SHEPHERD FLD (MRB)

(CLTCH3:CLTCH) 22083  
CLTCH THREE DEPARTURE (RNAV)

EASTERN WV RGNL/SHEPHERD FLD (MRB)  
MARTINSBURG, WEST VIRGINIA  
AL-249 (FAA)

(JDUBB4.JDUBB) 22083

EASTERN WV RGNL/SHEPHERD FLD (M.R.B)

# JDUBB FOUR DEPARTURE (RNAV) AL-249 (FAA)

MARTINSBURG, WEST VIRGINIA

ASOS 119.925  
 CLNC DEL  
 121.8 257.65  
 132.075 269.075 (When twr closed)  
 GND CON  
 121.8 257.65  
 MARTINSBURG TOWER ★  
 124.3 (CTAF) 233.7  
 POTOMAC DEP CON  
 126.825 239.025

**TOP ALTITUDE:**  
**3000**

### TAKEOFF MINIMUMS

Rwy 8: Standard.  
 Rwy 26: Standard with a minimum  
 climb of 225' per NM to 2100.

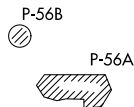

- NOTE: RNAV 1.
- NOTE: RADAR required.
- NOTE: DME/DME/IRU or GPS required.
- NOTE: Turbo-jets only.
- NOTE: Takeoff Rwy 8: If issued an ATC heading that requires a westbound turn, climb heading 081° to 1200 prior to turning for obstacle avoidance.
- NOTE: Takeoff Rwy 26: If issued an ATC heading that requires a right turn, climb heading 261° to 2400 prior to turning for obstacle avoidance.

NE-4, 22 FEB 2024 to 21 MAR 2024

NE-4, 22 FEB 2024 to 21 MAR 2024

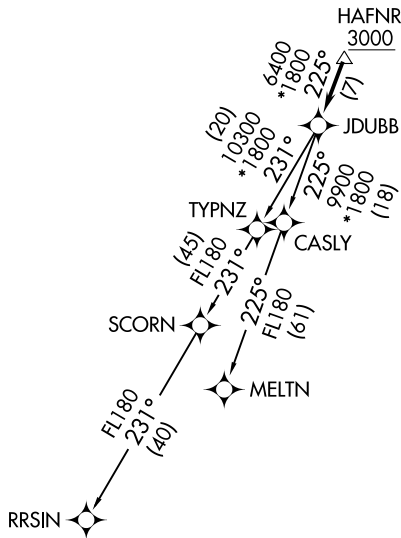

**DEPARTURE ROUTE DESCRIPTION**

Climb on heading assigned by ATC, expect RADAR vectors to HAFNR, then on track 225° to JDUBB, thence. . . .

. . . . on assigned transition, maintain 3000, expect clearance to filed altitude within ten (10) minutes after departure.

MELTN TRANSITION (JDUBB4.MELTN)  
RRSIN TRANSITION (JDUBB4.RRSIN)

NOTE: Chart not to scale.

JDUBB FOUR DEPARTURE (RNAV)  
 (JDUBB4.JDUBB) 31DEC20

MARTINSBURG, WEST VIRGINIA  
 EASTERN WV RGNL/SHEPHERD FLD (M.R.B)

SCRAM SIX DEPARTMENT (RNAV)  
(SCRAM6, SCRAM) 31 DEC 20

MARTINSBURG, WEST VIRGINIA  
EASTERN WV RGNL/SHEPHERD FLD (MIRB)

ASOS 119.925  
CLNIC DEL  
121.8 257.65  
132.075 269.075 (When Tower Closed)  
GND CON  
121.8 257.65  
MARTINSBURG TOWER ★  
124.3 (CTAF) 233.7  
POTOMAC DEP CON  
126.825 239.025

▼ DEPARTURE ROUTE DESCRIPTION

Climb on heading assigned by ATC, expect RADAR vectors to POOCH, then on track 240° to SCRAM, thence. . . .  
. . . . as depicted. Maintain 3000, expect clearance to filed altitude within ten (10) minutes after departure.

GLANC TRANSITION (SCRAM6.GLANC):

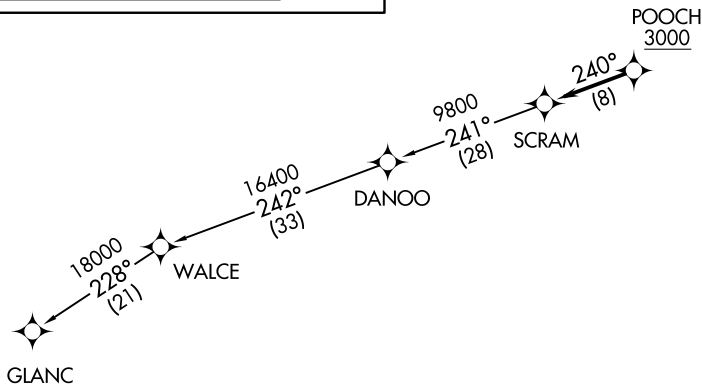

TAKEOFF MINIMUMS

Rwy 8: Standard.  
Rwy 26: Standard with a minimum climb of 225' per NM to 2100.

- NOTE: RNAV 1.
- NOTE: RADAR required.
- NOTE: DME/DME/IRU or GPS required.
- NOTE: Turbo-jets only.
- NOTE: Takeoff Rwy 8, if issued an ATC heading that requires a westbound turn, climb heading 081° to 1200 prior to turning for obstacle avoidance.
- NOTE: Takeoff Rwy 26, if issued an ATC heading that requires a right turn, climb heading 261° to 2400 prior to turning for obstacle avoidance.

NOTE: Chart not to scale.

TOP ALTITUDE:  
3000



(SCRAM6, SCRAM) 22083  
SCRAM SIX DEPARTMENT (RNAV)

A1-249 (FAA)  
EASTERN WV RGNL/SHEPHERD FLD (MIRB)  
MARTINSBURG, WEST VIRGINIA

(TRIXY5.TRIXY) 23334

EASTERN WV RGNL/SHEPHERD FLD (MRB)

# TRIXY FIVE DEPARTURE

AL-249 (FAA)

MARTINSBURG, WEST VIRGINIA

ASOS  
 119.925  
 CLNC DEL  
 121.8 257.65  
 132.075 269.075 (When Tower Closed)  
 GND CON  
 121.8 257.65  
 MARTINSBURG TOWER\*  
 124.3 (CTAF) 233.7  
 POTOMAC DEP CON  
 126.825 239.025

### TAKEOFF MINIMUMS

Rwy 8: Standard.  
 Rwy 26: Standard with minimum climb  
 of 300' per NM to 5000'.

**TOP ALTITUDE:  
 6000**

KESSEL  
 110.8 ESL :...  
 Chan 45



R-103

6000  
 283°  
 (41)

TRIXY  
 5000

6000

199°

(18)

R-019

LINDEN  
 114.3 LDN :...  
 Chan 90



ARMEL  
 113.5 AML :...  
 Chan 82

R-300

6000  
 120°  
 (33)

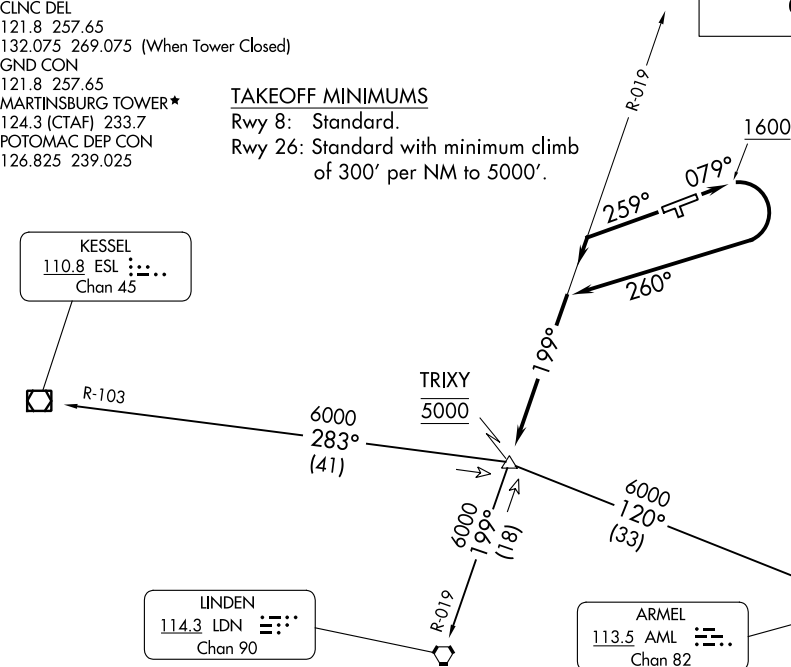

Note: Chart not to scale.

### DEPARTURE ROUTE DESCRIPTION

**TAKEOFF RUNWAY 8:** Climb heading 079° to 1600, then climbing right turn heading 260° to intercept LDN VORTAC R-019 to cross TRIXY INT at 5000, then on transition or assigned route, thence . . . .

**TAKEOFF RUNWAY 26:** Climb heading 259° to intercept LDN VORTAC R-019 to cross TRIXY INT at 5000, then on transition or assigned route, thence . . . . maintain 6000, expect filed altitude/flight level ten minutes after departure.

**ARMEL TRANSITION (TRIXY5.AML):** From over TRIXY INT on AML R-300 to AML VOR/DME.

**KESSEL TRANSITION (TRIXY5.ESL):** From over TRIXY INT on ESL R-103 to ESL VOR/DME.

**LINDEN TRANSITION (TRIXY5.LDN):** From over TRIXY INT on LDN R-019 to LDN VORTAC.

# TRIXY FIVE DEPARTURE

(TRIXY5.TRIXY) 31MAR16

MARTINSBURG, WEST VIRGINIA

EASTERN WV RGNL/SHEPHERD FLD (MRB)

NE-4, 22 FEB 2024 to 21 MAR 2024

NE-4, 22 FEB 2024 to 21 MAR 2024

LOC I-EXW <b>108.3</b>	APP CRS <b>259°</b>	Rwy Idg <b>7815</b>
		TDZE <b>548</b>
		Apt Elev <b>565</b>

# ILS or LOC RWY 26

EASTERN WV RGNL/SHEPHERD FLD (MRB)

**⚠** For inoperative MALS/R, increase S-ILS 26 Cat E visibility to ¾ mile and S-LOC 26 Cat E visibility to 1¼ mile. When local altimeter setting not received, use Hagerstown altimeter setting and increase all DA 70 feet and all MDA 80 feet; increase S-LOC 26 Cat C, D, E and Circling Cat C and D visibility ¼ mile. For inoperative MALS/R when using Hagerstown altimeter setting increase S-ILS 26 visibility all Cats to 1 mile and S-LOC 26 Cat E visibility to 1½ mile.

**MALS/R**  
  
**MISSED APPROACH:** Climb to 1100 then climbing left turn to 3300 direct MRB VORTAC and hold, continue climb-in-hold to 3300.

ASOS <b>119.925</b>	POTOMAC APP CON <b>126.825 239.025</b>	MARTINSBURG TOWER * <b>124.3 (CTAF) 233.7</b>	GND CON <b>121.8 257.65</b>	CLNC DEL <b>121.8 257.65</b>	CLNC DEL <b>132.075 269.075</b> (When twr closed)
------------------------	---	--	--------------------------------	---------------------------------	---

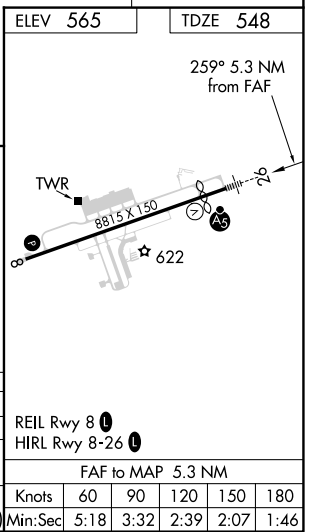
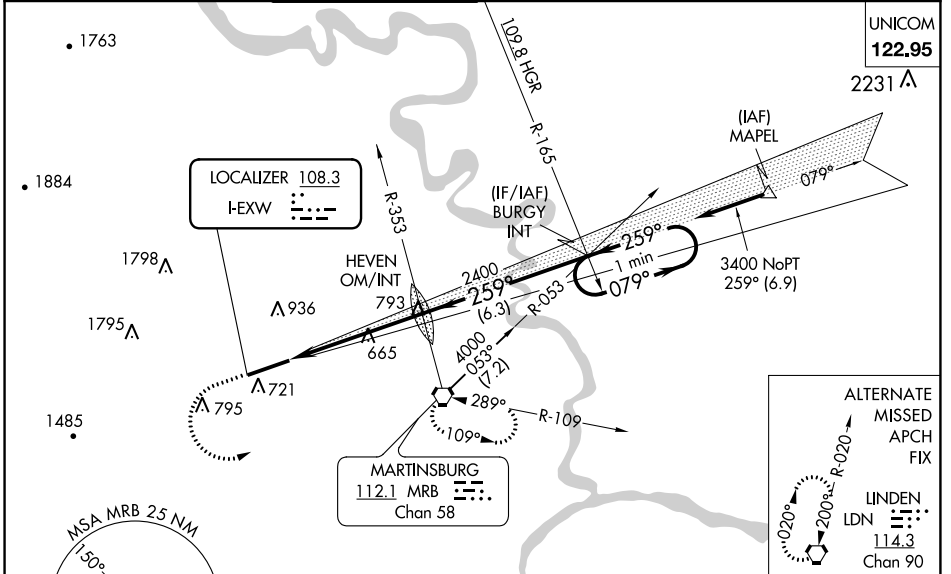

CATEGORY	A	B	C	D	E
S-ILS 26	748-½ 200 (200-½)				
S-LOC 26	920-½ 372 (400-½)		920-¾ 372 (400-¾)		
<b>CIRCLING</b>	1100-1 535 (600-1)	1240-1 675 (700-1)	1240-2 675 (700-2)	1260-2¼ 695 (700-2¼)	2140-3 1575 (1600-3)

NE-4, 22 FEB 2024 to 21 MAR 2024

NE-4, 22 FEB 2024 to 21 MAR 2024

WAAS CH <b>53609</b> <b>W26A</b>	APP CRS <b>259°</b>	Rwy Idg TDZE <b>548</b> Apt Elev <b>565</b>	<b>7815</b>
--	------------------------	---	-------------

# RNAV (GPS) RWY 26

EASTERN WV RGNL/SHEPHERD FLD (MRB)

**RNP APCH**

▼ Baro-VNAV NA when using Hagerstown altimeter setting. For uncompensated Baro-VNAV systems, LNAV/VNAV NA below -16°C (4°F) or above 54°C (130°F). VDP NA when using Hagerstown altimeter setting. When local altimeter setting not received, use Hagerstown altimeter setting and increase all DA 70 feet and all MDA 80 feet, increase LNAV/VNAV all Cats, LNAV Cats C, D, E and Circling Cat C and D visibility ¼ mile. For inoperative MALSRL increase LPV Cat E visibility to ¾ mile, LNAV/VNAV Cat E to 2¼ mile, LNAV Cat E to 1½ mile. For inoperative MALSRL when using Hagerstown altimeter setting increase LPV all Cats visibility to 1 mile, LNAV/VNAV Cat E visibility to 2½ mile and LNAV Cat E visibility to 1¾ mile.



MALSRL 

MISSED APPROACH: Climb to 4100 direct JOSRU and hold, continue climb-in-hold to 4100.

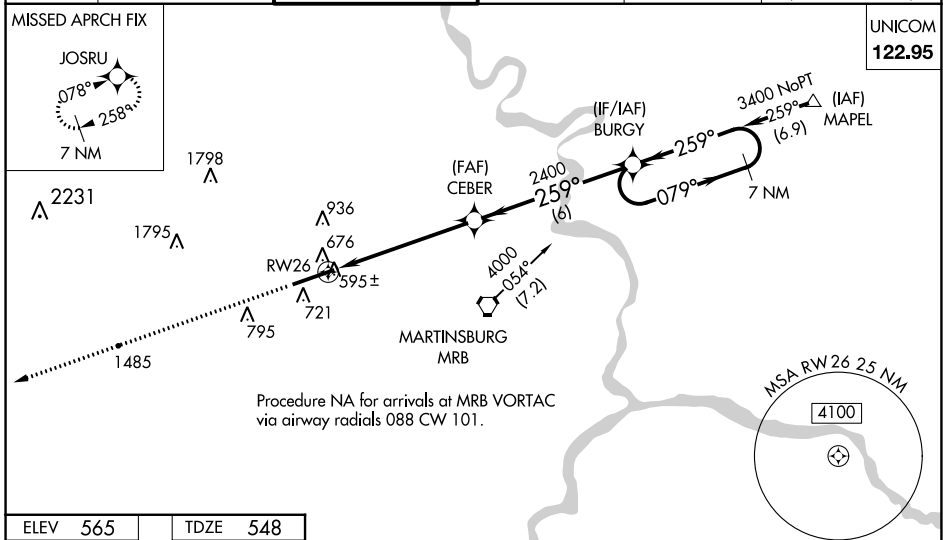
ASOS <b>119.925</b>	POTOMAC APP CON <b>126.825 239.025</b>	MARTINSBURG TOWER ★ <b>124.3</b> (CTAF) <b>233.7</b>	GND CON <b>121.8 257.65</b>	CLNC DEL <b>121.8 257.65</b>	CLNC DEL <b>132.075 269.075</b> (When twr closed)
------------------------	---	---	--------------------------------	---------------------------------	---



ELEV 565 TDZE 548

REIL Rwy 8   
HIRL Rwy 8-26 

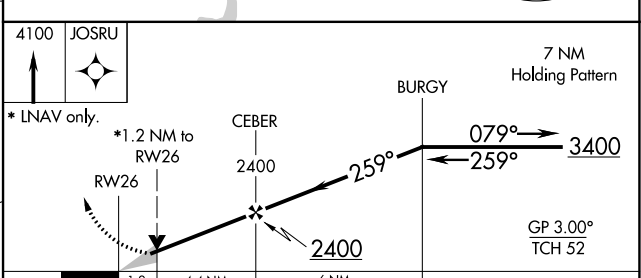

CATEGORY	A	B	C	D	E
LPV DA	798-½		250 (300-½)		
LNAV/VNAV DA	1213-1¾		665 (700-1¾)		
LNAV MDA	980-½	432 (500-½)	980-¾ 432 (500-¾)	980-1	432 (500-1)
 CIRCLING	1100-1 535 (600-1)	1240-1 675 (700-1)	1240-2 675 (700-2)	1260-2 ¼ 695 (700-2 ¼)	2140-3 1575 (1600-3)

NE-4, 22 FEB 2024 to 21 MAR 2024

NE-4, 22 FEB 2024 to 21 MAR 2024

WAAS CH <b>99633</b> <b>W08A</b>	APP CRS <b>079°</b>	Rwy Idg TDZE Apt Elev	<b>8815</b> <b>565</b> <b>565</b>
--	------------------------	-----------------------------	---

# RNAV (GPS) RWY 8

EASTERN WV RGNL/SHEPHERD FLD (MRB)

RNP APCH - GPS.					MISSED APPROACH: Climb to 3400 direct BURGY and hold.
For uncompensated Baro-VNAV systems, LNAV/VNAV NA below -14°C or above 54°C.					

ASOS <b>119.925</b>	POTOMAC APP CON <b>126.825 239.025</b>	MARTINSBURG TOWER * <b>124.3</b> (CTAF) <b>233.7</b>	GND CON <b>121.8 257.65</b>	CLNC DEL <b>121.8 257.65</b>	CLNC DEL <b>132.075 269.075</b> (When twr closed)
------------------------	---	---	--------------------------------	---------------------------------	---

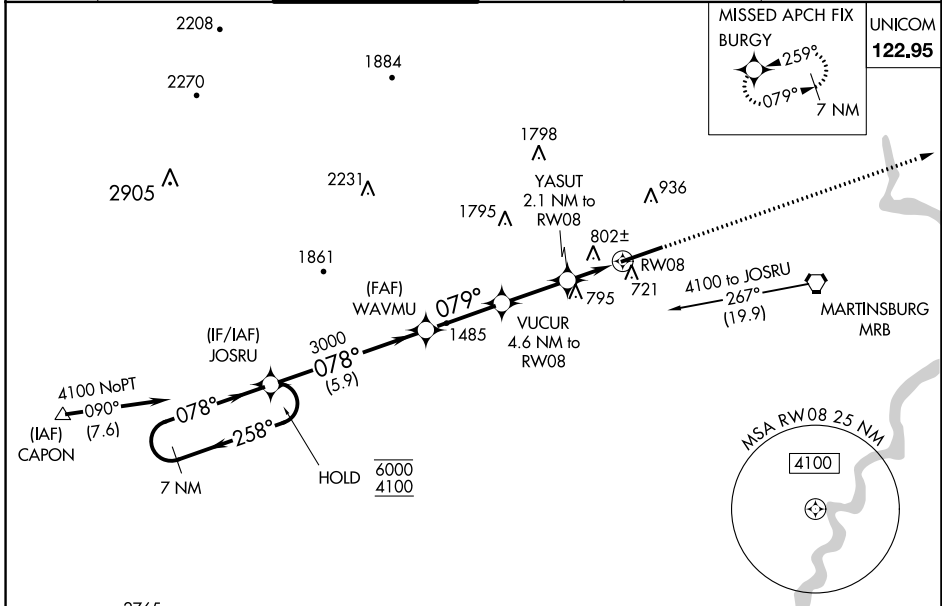

NE-4, 22 FEB 2024 to 21 MAR 2024

NE-4, 22 FEB 2024 to 21 MAR 2024

ELEV 565	TDZE 565
----------	----------

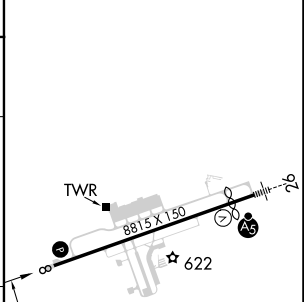
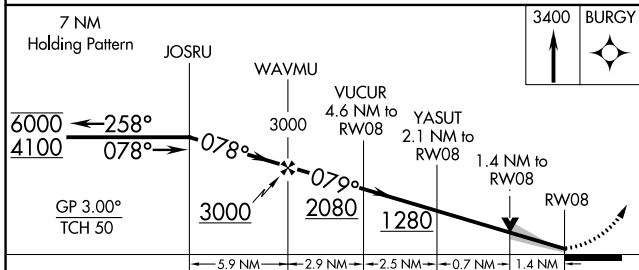

CATEGORY	A	B	C	D	E
LPV DA	815-3/4		250 (300-3/4)		
LNAV/DA VNAV	1059-1 3/8		494 (500-1 3/8)		
LNAV MDA	1060-1	495 (500-1)	1060-1 3/8	495 (500-1 3/8)	
CIRCLING	1100-1	1240-1	1240-2	1260-2 1/4	2140-3
	535 (600-1)	675 (700-1)	675 (700-2)	695 (700-2 1/4)	11575 (1600-3)

REIL Rwy 8	HIRL Rwy 8-26
------------	---------------



VORTAC MRB <b>112.1</b> Chan <b>58</b>	APP CRS <b>290°</b>	Rwy Idg TDZE Apt Elev <b>N/A</b> <b>N/A</b> <b>565</b>
--	------------------------	---

# VOR-A

EASTERN WV RGNL/SHEPHERD FLD (MRB)

**⚠** When local altimeter setting not received, use Hagerstown altimeter setting and increase all MDA 80 feet and Cat C/D visibility ¼ mile.

**MISSED APPROACH:** Climbing left turn to 3000 direct MRB VORTAC and hold, continue climb in hold to 3000.

ASOS <b>119.925</b>	POTOMAC APP CON <b>126.825 239.025</b>	MARTINSBURG TOWER ★ <b>124.3</b> (CTAF) <b>233.7</b>	GND CON <b>121.8 257.65</b>	CLNC DEL <b>121.8 257.65</b>	CLNC DEL <b>132.075 269.075</b> (When twr closed)
------------------------	---	---	--------------------------------	---------------------------------	---

UNICOM  
**122.95**

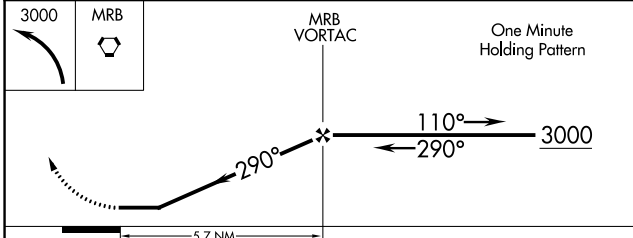
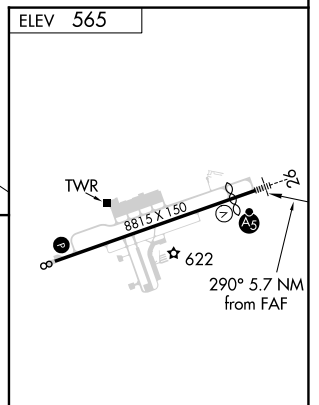
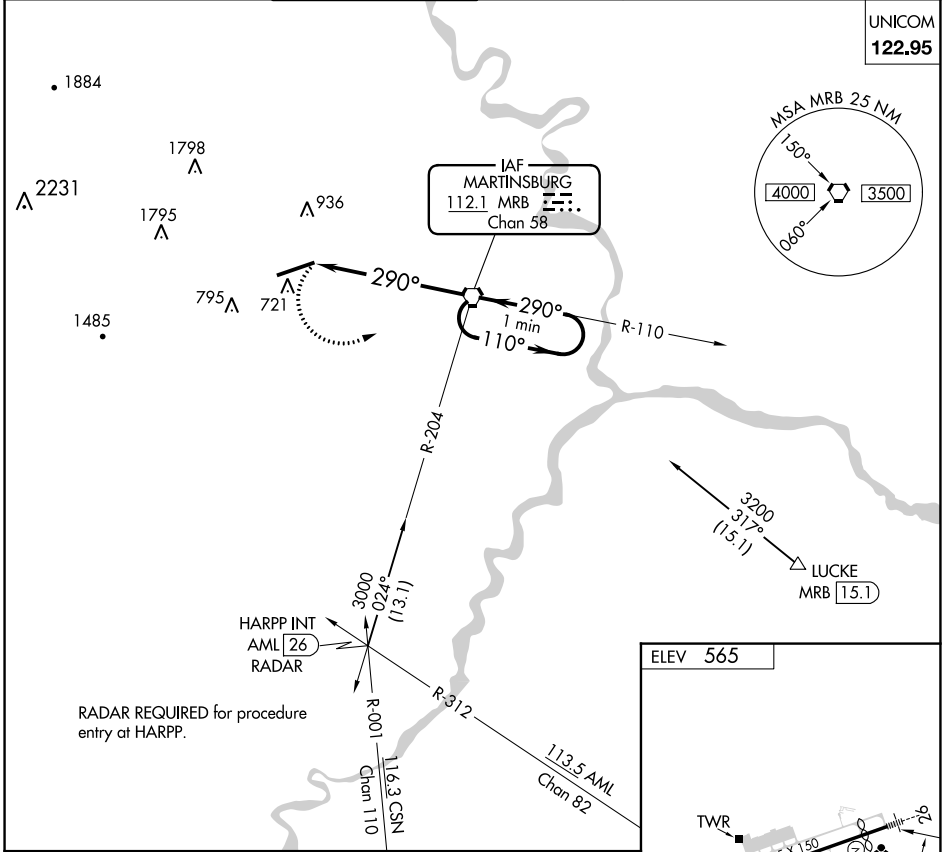

CATEGORY	FAF to MAP 5.7 NM				
	A	B	C	D	E
<b>C</b> CIRCLING	1120-1 555 (600-1)	1240-1 675 (700-1)	1240-2 675 (700-2)	1260-2¼ 695 (700-2¼)	2140-3 1575 (1600-3)
	Knots	60	90	120	150
	Min:Sec	5:42	3:48	2:51	2:17
		180	1:54		

# VOR-A

NE-4, 22 FEB 2024 to 21 MAR 2024

NE-4, 22 FEB 2024 to 21 MAR 2024

INSTRUMENT APPROACH PROCEDURE CHARTS

**IFR ALTERNATE AIRPORT MINIMUMS**

Pilots must review the IFR Alternate Minimums Notes to determine alternate airport suitability.

▲NA designation on the approach chart means that pilots may not use that approach as an alternate due to unmonitored facility, absence of weather reporting service, or lack of adequate navigation coverage. Approaches with the ▲NA designation are not listed in this section. ▲ designation on the approach chart indicates that the approach procedure has non-standard minimums (for aircraft other than helicopters) or restrictions (for all users) for its use as an alternate.

Alternate Minima (ref: 14 CFR 91.169)

	Precision Approach	Non-Precision Approach
Standard	<b>600-2</b>	<b>800-2</b>
▲Non-Standard or restrictions	As indicated below	As indicated below
Helicopters	For the selected approach: Ceiling: 200' above published ceiling Visibility: the greater of 1 SM visibility or the published visibility	
US Military (USA/USN/USAF)	See Service Regulations	

**Note:** For alternate airport flight planning purposes, precision approach operations include: ILS, PAR, and GLS, and Non-Precision approach operations include: NDB, VOR, LOC, TACAN, LDA, SDF, ASR, RNAV (GPS) and RNAV (RNP).

NAME ALTERNATE MINIMUMS

**ALLENTOWN, PA**

LEHIGH VALLEY  
INTL (ABE).....**ILS or LOC Rwy 6<sup>1</sup>**  
  **ILS or LOC Rwy 13<sup>2</sup>**  
  **ILS or LOC/DME Rwy 24<sup>1</sup>**  
  **RNAV (GPS) Rwy 6<sup>3</sup>**  
  **RNAV (GPS) Rwy 13<sup>3</sup>**  
  **RNAV (GPS) Rwy 24<sup>3</sup>**  
  **RNAV (GPS) Rwy 31<sup>3</sup>**

<sup>1</sup>LOC, Category C, 800-2½; Category D, 1300-3.  
<sup>2</sup>ILS, LOC, Categories A, B, 900-2; Category C, 900-2½; Category D, 1300-3.  
<sup>3</sup>Category C, 800-2½; Category D, 1300-

QUEEN CITY  
MUNI (XLL).....**RNAV (GPS) Rwy 7**  
Category C, 1000-2½.  
NA when local weather not available.

**ALTOONA, PA**

ALTOONA/BLAIR  
COUNTY (AOO).....**ILS or LOC Rwy 21<sup>1</sup>**  
  **RNAV (GPS) Rwy 21<sup>2</sup>**  
  **RNAV (GPS) Y Rwy 3<sup>2</sup>**

NA when local weather not available.  
<sup>1</sup>LOC, Category C, 1300-3; Category D, 1400-3.  
<sup>2</sup>Category C, 1300-3; Category D, 1400-3.

NAME ALTERNATE MINIMUMS

**BEAVER FALLS, PA**

BEAVER  
COUNTY (BVI).....**LOC Rwy 10<sup>1</sup>**  
  **VOR Rwy 28<sup>2</sup>**

<sup>1</sup>NA when control tower closed.  
<sup>2</sup>Categories A, B, 900-2; Categories C, D, 900-2½.

**BECKLEY, WV**

RALEIGH COUNTY  
MEML (BKW).....**ILS or LOC Rwy 19<sup>1</sup>**  
  **RNAV (GPS) Rwy 1<sup>2</sup>**  
  **RNAV (GPS) Rwy 10<sup>2</sup>**  
  **RNAV (GPS) Rwy 19<sup>2</sup>**  
  **RNAV (GPS) Rwy 28<sup>3</sup>**  
  **VOR Rwy 10<sup>2</sup>**

NA when local weather not available.  
<sup>1</sup>LOC, Category C, 900-2½; Category D, 1000-3.  
<sup>2</sup>Category C, 900-2½; Category D, 1000-3.  
<sup>3</sup>Categories A, B, 900-2; Category C, 900-2½; Category D, 1000-3.

**BEDFORD, PA**

BEDFORD  
COUNTY (HMZ).....**RNAV (GPS) Rwy 14<sup>1</sup>**  
  **RNAV (GPS) Rwy 32<sup>2,3</sup>**

<sup>1</sup>Categories A, B, 900-4; Category C, 1100-4; Category D, 1800-4.  
<sup>2</sup>Category C, 1100-3.  
<sup>3</sup>NA when local weather not available.

## NAME ALTERNATE MINIMUMS

**BLUEFIELD, WV**

MERCER  
 COUNTY (BLF).....**ILS or LOC Rwy 23**<sup>12</sup>  
**RNAV (GPS) Rwy 5**<sup>34</sup>  
**RNAV (GPS) Rwy 23**<sup>35</sup>  
**VOR Rwy 23**<sup>36</sup>

<sup>1</sup>LOC, NA when local weather not available.<sup>2</sup>LOC, Category C, 800-2½; Category D, 1000-3.<sup>3</sup>NA when local weather not available.<sup>4</sup>Category D, 800-2½.<sup>5</sup>Category C, 800-2½; Category D, 800-2½.<sup>6</sup>Category C, 800-2½; Category D, 1000-3.**BRADFORD, PA**

BRADFORD  
 RGNL (BFD).....**RNAV (GPS) Rwy 14**  
**RNAV (GPS) Rwy 32**

NA when local weather not available.

**BUCKHANNON, WV**

UPSHUR COUNTY  
 RGNL (W22).....**RNAV (GPS) Rwy 11**  
**RNAV (GPS) Rwy 29**<sup>1</sup>

Category C, 800-2½.

<sup>1</sup>NA when local weather not available.**BUTLER, PA**

PITTSBURGH/BUTLER  
 RGNL (BTP).....**ILS or LOC Rwy 8**<sup>12</sup>  
**RNAV (GPS) Rwy 8**<sup>3</sup>  
**RNAV (GPS) Rwy 26**<sup>3</sup>

<sup>1</sup>NA when local weather not available.<sup>2</sup>LOC, Category C, 900-2½; Category D, 900-2¾.<sup>3</sup>Category C, 900-2½; Category D, 900-2¾.**CHARLESTON, WV**

WEST VIRGINIA INTL  
 YEAGER (CRW).....**ILS or LOC Rwy 5**<sup>1</sup>  
**RNAV (GPS) Y Rwy 5**<sup>2</sup>  
**RNAV (GPS) Y Rwy 23**<sup>3</sup>  
**RNAV (RNP) Z Rwy 23**<sup>4</sup>  
**VOR-A**<sup>2</sup>

<sup>1</sup>LOC, Category C, 900-2½; Category D, 1000-3.<sup>2</sup>Category C, 900-2½; Category D, 1000-3.<sup>3</sup>Category C, 900-2½; Category D, 900-2¾.<sup>4</sup>NA when local weather not available.**CLARKSBURG, WV**

NORTH CENTRAL  
 WEST VIRGINIA (CKB).....**ILS or LOC Rwy 21**<sup>12</sup>  
**RNAV (GPS) Rwy 3**<sup>3</sup>  
**RNAV (GPS) Rwy 21**<sup>4</sup>  
**VOR-A**<sup>56</sup>

<sup>1</sup>NA when control tower closed.<sup>2</sup>LOC, Category B, 900-2; Categories C, D, 1100-3.<sup>3</sup>Category B, 900-2; Categories C, D, 1100-3.<sup>4</sup>Categories C, D, 1100-3.<sup>5</sup>Category D, 900-2¾.<sup>6</sup>NA when local weather not available.

## NAME ALTERNATE MINIMUMS

**CLEARFIELD, PA**

CLEARFIELD-  
 LAWRENCE (FIG).....**RNAV (GPS) Rwy 12**<sup>1</sup>  
**RNAV (GPS) Rwy 30**<sup>2</sup>

NA when local weather not available.

<sup>1</sup>Category C, 900-2½.<sup>2</sup>Category C, 900-2½; Category D, 1200-3.**COATESVILLE, PA**

CHESTER COUNTY  
 G O CARLSON (MQS).....**ILS or LOC Rwy 29**<sup>1</sup>  
**RNAV (GPS) Rwy 11**<sup>2</sup>  
**RNAV (GPS) Rwy 29**<sup>2</sup>

NA when local weather not available.

<sup>1</sup>LOC, Category D, 800-2½.<sup>2</sup>Category D, 800-2½.**DOYLESTOWN, PA**

DOYLESTOWN (DYL).....**RNAV (GPS) Rwy 5**  
**RNAV (GPS) Rwy 23**  
**VOR-A**<sup>1</sup>

NA when local weather not available.

<sup>1</sup>Categories A, B, 900-2.**DUBOIS, PA**

DUBOIS RGNL (DUJ).....**ILS or LOC Rwy 25**  
**RNAV (GPS) Rwy 7**  
**RNAV (GPS) Rwy 25**

NA when local weather not available.

**ELKINS, WV**

ELKINS/RANDOLPH COUNTY (JENNINGS  
 RANDOLPH FLD) (EKN).....**LDA-C**<sup>1</sup>  
**RNAV (GPS) Rwy 5**<sup>2</sup>  
**RNAV (GPS) Rwy 23**<sup>3</sup>  
**RNAV (GPS)-A**<sup>4</sup>

NA when local weather not available.

<sup>1</sup>Categories A, B, 1200-2; Category C, 1800-3; Category D, 2100-3.<sup>2</sup>Categories A, B, 1400-2; Category C, 1800-3; Category D, 2100-3.<sup>3</sup>Categories A, B, 1200-2; Category C, 1800-3; Category D, 1200-3.<sup>4</sup>Categories A, B, 1700-2; Category C, 1800-3.**ERIE, PA**

ERIE INTL/TOM RIDGE  
 FLD (ERI).....**ILS or LOC Rwy 6**<sup>1</sup>  
**ILS or LOC Rwy 24**<sup>1</sup>  
**RNAV (GPS) Rwy 6**  
**RNAV (GPS) Rwy 24**

NA when local weather not available.

<sup>1</sup>NA when control tower closed.**FRANKLIN, PA**

VENANGO RGNL (FKL).....**ILS or LOC Rwy 21**  
**RNAV (GPS) Rwy 3**  
**RNAV (GPS) Rwy 21**  
**VOR Rwy 21**

NA when local weather not available.

NAME ALTERNATE MINIMUMS

**HARRISBURG, PA**

CAPITAL CITY (CXY).....**ILS or LOC Rwy 8<sup>123</sup>**  
**RNAV (GPS) Rwy 8<sup>25</sup>**  
**RNAV (GPS) Rwy 26<sup>34</sup>**

- <sup>1</sup>Categories A, 1000-2; Category B, 1400-2;  
Categories C, D, 1400-3.
- <sup>2</sup>NA when control tower closed.
- <sup>3</sup>NA when local weather not available.
- <sup>4</sup>Category A, 1200-2, Category B, 1400-2;  
Categories C, D, 1400-3.
- <sup>5</sup>Category A, 900-2; Category B, 1400-2;  
Categories C, D, 1400-3.

**HARRISBURG**

INTL (MDT).....**ILS or LOC Rwy 13<sup>1</sup>**  
**ILS or LOC Rwy 31<sup>1</sup>**  
**RNAV (GPS) Rwy 13<sup>2</sup>**  
**RNAV (GPS) Rwy 31<sup>3</sup>**  
**VOR Rwy 31<sup>4</sup>**

- <sup>1</sup>LOC, Category D, 1200-3.
- <sup>2</sup>Categories A, B, C, D, 1300-5.
- <sup>3</sup>Category C, 800-2¼; Category D, 1200-3.
- <sup>4</sup>Categories A, B, 1000-2; Category C, 1000-3;  
Category D, 1200-3.

**HAZLETON, PA**

HAZLETON RGNL (HZL).....**RNAV (GPS) Rwy 10**  
**RNAV (GPS) Rwy 28**  
Category C, 900-2½; Category D, 1000-3.

**HUNTINGTON, WV**

TRI-STATE/MILTON J FERGUSON  
FLD (HTS).....**ILS or LOC Rwy 12<sup>1</sup>**  
**ILS or LOC Rwy 30<sup>1</sup>**  
**RNAV (GPS) Rwy 12<sup>2</sup>**  
**RNAV (GPS) Rwy 30<sup>2</sup>**

- <sup>1</sup>LOC, Category D, 1000-3.
- <sup>2</sup>Category D, 1000-3.

**INDIANA, PA**

INDIANA COUNTY/JIMMY STEWART  
FLD (IDI).....**RNAV (GPS) Rwy 11**  
**RNAV (GPS) Rwy 29**

- NA when local weather not available.
- Categories C, D, 1300-3.

NAME ALTERNATE MINIMUMS

**JOHNSTOWN, PA**

JOHN MURTHA JOHNSTOWN/CAMBRIA  
COUNTY (JST).....**ILS or LOC Rwy 33<sup>123</sup>**  
**RNAV (GPS) Rwy 5<sup>4</sup>**  
**RNAV (GPS) Rwy 15<sup>4</sup>**  
**RNAV (GPS) Rwy 23<sup>4</sup>**  
**RNAV (GPS) Rwy 33<sup>4</sup>**  
**VOR Rwy 5<sup>24</sup>**  
**VOR Y Rwy 15<sup>5</sup>**  
**VOR Z Rwy 15<sup>4</sup>**  
**VOR Y Rwy 23<sup>1</sup>**  
**VOR Z Rwy 23<sup>4</sup>**

- <sup>1</sup>NA when control tower closed.
- <sup>2</sup>NA when local weather not available.
- <sup>3</sup>LOC, Category D, 800-2¼.
- <sup>4</sup>Category D, 800-2¼.
- <sup>5</sup>Categories A, B, 1100-2;  
Categories C, D, 1100-3.

**LANCASTER, PA**

LANCASTER (LNS).....**ILS or LOC Rwy 8<sup>123</sup>**  
**RNAV (GPS) Rwy 8<sup>2</sup>**  
**RNAV (GPS) Rwy 13<sup>2</sup>**  
**RNAV (GPS) Rwy 26<sup>2</sup>**  
**RNAV (GPS) Rwy 31<sup>2</sup>**  
**VOR/DME Rwy 31<sup>24</sup>**  
**VOR/DME Rwy 8<sup>2</sup>**  
**VOR/DME Rwy 26<sup>24</sup>**  
**VOR Rwy 8<sup>25</sup>**  
**VOR Rwy 31<sup>4</sup>**

- <sup>1</sup>NA when control tower closed.
- <sup>2</sup>NA when local weather not available.
- <sup>3</sup>LOC, Category D, 800-2¼.
- <sup>4</sup>Category D, 800-2¼.
- <sup>5</sup>Categories A, B, 1000-2; Categories C, D,  
1000-3.

**LATROBE, PA**

ARNOLD PALMER  
RGNL (LBE).....**ILS or LOC Rwy 24<sup>123</sup>**  
**RNAV (GPS) Rwy 6<sup>4</sup>**  
**RNAV (GPS) Rwy 24<sup>4</sup>**

- <sup>1</sup>NA when control tower closed.
- <sup>2</sup>NA when local weather not available.
- <sup>3</sup>LOC, Categories A, B, 1200-2;  
Categories C, D, 1200-3.
- <sup>4</sup>Category C, 900-2½; Category D, 900-2¾.

**LEHIGHTON, PA**

JAKE ARNER  
MEML (22N).....**RNAV (GPS) Rwy 8<sup>1</sup>**  
**RNAV (GPS) Rwy 26<sup>2</sup>**

- <sup>1</sup>Categories A, B, 1100-2.
- <sup>2</sup>Category A, 1000-2; Category B, 1300-2.

NAME ALTERNATE MINIMUMS

**LEWISBURG, WV**

GREENBRIER VALLEY (LWB).....**ILS or LOC Rwy 4<sup>12</sup>**  
**RNAV (GPS) Rwy 4<sup>13</sup>**  
**RNAV (GPS) Rwy 22<sup>4</sup>**

- <sup>1</sup>NA when local weather not available.
- <sup>2</sup>LOC, Category C, 1000-3; Category D, 1400-3.
- <sup>3</sup>Category C, 1000-3; Category D, 1400-3.
- <sup>4</sup>Category C, 1000-3; Category D, 1300-3.

**LOGAN, WV**

LOGAN COUNTY (6L4).....**RNAV (GPS) Rwy 6<sup>1</sup>**  
**RNAV (GPS) Rwy 24**

- Category C, 1100-3.
- <sup>1</sup>NA when local weather not available.

**MARTINSBURG, WV**

EASTERN WV RGNL/SHEPHERD FLD (MRB).....**ILS or LOC Rwy 26<sup>12</sup>**  
**RNAV (GPS) Rwy 8<sup>3</sup>**  
**RNAV (GPS) Rwy 26<sup>14</sup>**  
**VOR-A<sup>13</sup>**

- <sup>1</sup>NA when local weather not available.
- <sup>2</sup>ILS, LOC, Category D, 900-2½; Category E, 1600-3.
- <sup>3</sup>Category D, 800-2¼; Category E, 1600-3.
- <sup>4</sup>Category D, 900-2¾; Category E, 1600-3.

**MEADVILLE, PA**

PORT MEADVILLE (GKJ).....**LOC Rwy 25<sup>1</sup>**  
**RNAV (GPS) Rwy 7**  
**RNAV (GPS) Rwy 25**

- Category B, 900-2; Category C, 900-2½; Category D, 900-2¾.
- <sup>1</sup>NA when local weather not available.

**MORGANTOWN, WV**

MORGANTOWN MUNI/WALTER L BILL HART FLD (MGW).....**ILS or LOC Rwy 18<sup>12</sup>**  
**RNAV (GPS) Y Rwy 18<sup>34</sup>**  
**RNAV (GPS) Z Rwy 18<sup>34</sup>**  
**RNAV (GPS) Rwy 36<sup>34</sup>**

- <sup>1</sup>NA when control tower closed.
- <sup>2</sup>LOC, Category C, 1000-2¾; Category D, 1400-3.
- <sup>3</sup>NA when local weather not available.
- <sup>4</sup>Category C, 1000-2¾; Category D, 1400-3.

**MOUNT POCONO, PA**

POCONO MOUNTAINS RGNL (MPO).....**RNAV (GPS) Rwy 5**  
**RNAV (GPS) Rwy 13**  
**RNAV (GPS) Rwy 31**  
**VOR/DME Rwy 13**

- NA when local weather not available.
- Category D, 800-2½.

NAME ALTERNATE MINIMUMS

**MYERSTOWN, PA**

DECK (9D4).....**RNAV (GPS) Rwy 19**  
NA when local weather not available.

**NEW CASTLE, PA**

NEW CASTLE MUNI (UCP).....**RNAV (GPS) Rwy 5**  
**RNAV (GPS) Rwy 23**  
NA when local weather not available.

**PARKERSBURG, WV**

MID-OHIO VALLEY RGNL (PKB).....**RNAV (GPS) Rwy 3<sup>1</sup>**  
**RNAV (GPS) Rwy 10<sup>2</sup>**  
**RNAV (GPS) Rwy 21<sup>1</sup>**  
**RNAV (GPS) Rwy 28<sup>1</sup>**

- NA when local weather not available.
- <sup>1</sup>Category C, 800-2¼; Category D, 800-2½.
- <sup>2</sup>Categories C, D, 800-2½.

**PETERSBURG, WV**

GRANT COUNTY (W99).....**RNAV (GPS)-C<sup>1</sup>**  
**RNAV (GPS) Y Rwy 31<sup>2</sup>**  
**RNAV (GPS) Z Rwy 31<sup>3</sup>**  
**VOR/DME-A<sup>4</sup>**

- NA when local weather not available.
- <sup>1</sup>Categories A, B, 1500-2.
- <sup>2</sup>Categories A, B, 1800-2.
- <sup>3</sup>Categories A, B, 1200-2.
- <sup>4</sup>Categories A, B, 2200-2.

**PHILADELPHIA, PA**

NORTHEAST PHILADELPHIA (PNE).....**ILS or LOC Rwy 24<sup>12</sup>**  
**RNAV (GPS) Rwy 6**  
**RNAV (GPS) Rwy 15**  
**RNAV (GPS) Rwy 24<sup>1</sup>**  
**RNAV (GPS) Rwy 33**

- NA when local weather not available.
- <sup>1</sup>NA when control tower closed.
- <sup>2</sup>ILS, Category D, 700-2.

NAME ALTERNATE MINIMUMS

**PHILADELPHIA, PA (CON'T)**

PHILADELPHIA  
INTL (PHL).....ILS or LOC Rwy 9L<sup>1</sup>  
 ILS or LOC Rwy 26<sup>3</sup>  
 ILS or LOC Rwy 27L<sup>4</sup>  
 ILS or LOC Rwy 27R<sup>4</sup>  
 ILS Z or LOC Z Rwy 9R<sup>2</sup>  
 ILS Z or LOC Rwy 17<sup>4</sup>  
 RNAV (GPS) Rwy 17<sup>5</sup>  
 RNAV (GPS) Rwy 27L<sup>5</sup>  
 RNAV (GPS) Rwy 27R<sup>5</sup>  
 RNAV (GPS) Rwy 35<sup>56</sup>  
 RNAV (GPS) Y Rwy 9L<sup>5</sup>  
 RNAV (GPS) Y Rwy 9R<sup>5</sup>

- <sup>1</sup>LOC, Category D, 800-2¼.
- <sup>2</sup>ILS, Categories A, B, C, 800-2; Category D, 800-2¼. LOC, Category D, 800-2¼.
- <sup>3</sup>ILS, Categories A, B, C, 700-2.
- <sup>4</sup>LOC, Category D, 800-2¼.
- <sup>5</sup>Category D, 800-2¼.
- <sup>6</sup>NA when local weather not available.

WINGS FLD (LOM).....RNAV (GPS) Rwy 6  
 RNAV (GPS) Rwy 24  
 NA when local weather not available.

**PITTSBURGH, PA**

ALLEGHENY  
COUNTY (AGC).....ILS or LOC Rwy 10<sup>1</sup>  
 ILS or LOC Rwy 28<sup>1</sup>  
 RNAV (GPS) Rwy 10<sup>2</sup>  
 RNAV (GPS) Rwy 28<sup>2</sup>

- <sup>1</sup>LOC, Category D, 800-2¼.
- <sup>2</sup>Category D, 800-2¼.

PITTSBURGH

INTL (PIT).....ILS or LOC Rwy 10L<sup>1</sup>  
 ILS or LOC Rwy 10R<sup>2</sup>  
 ILS or LOC Rwy 28L<sup>1</sup>  
 ILS or LOC Rwy 28R<sup>1</sup>  
 ILS or LOC Rwy 32<sup>1</sup>  
 RNAV (GPS) Rwy 10L<sup>3</sup>  
 RNAV (GPS) Rwy 14<sup>3</sup>  
 RNAV (GPS) Y Rwy 10C<sup>3</sup>  
 RNAV (GPS) Y Rwy 10R<sup>3</sup>  
 RNAV (GPS) Y Rwy 28C<sup>3</sup>  
 RNAV (GPS) Y Rwy 28L<sup>3</sup>  
 RNAV (GPS) Y Rwy 28R<sup>3</sup>  
 RNAV (GPS) Y Rwy 32<sup>3</sup>  
 RNAV (RNP) Z Rwy 10R<sup>4</sup>

- <sup>1</sup>LOC, Category D, 800-2¼, Category E, 800-2½.
- <sup>2</sup>ILS, Category C, 700-2; Category D, 700-2¼, Category E, 700-2½. LOC, Category D, 800-2¼, Category E, 800-2½.
- <sup>3</sup>Category D, 800-2¼.
- <sup>4</sup>NA when local weather not available.

NAME ALTERNATE MINIMUMS

**POINT PLEASANT, WV**

MASON COUNTY (3I2).....RNAV (GPS) Rwy 7<sup>1</sup>  
 RNAV (GPS) Rwy 25<sup>2</sup>

- NA when local weather not available.
- <sup>1</sup>Categories A, B, 1300-2; Category C, D, 1300-3.
- <sup>2</sup>Category A, B, 1100-2; Category C, D, 1100-3.

**POTTSTOWN, PA**

HERITAGE FLD (PTW).....LOC Rwy 28  
 RNAV (GPS)-A  
 RNAV (GPS) Rwy 28  
 VOR/DME-A

NA when local weather not available.

**QUAKERTOWN, PA**

QUAKERTOWN (UKT).....RNAV (GPS) Rwy 11  
 RNAV (GPS) Rwy 29

NA when local weather not available.

**READING, PA**

READING RGNL/CARL A  
 SPAATZ FLD (RDG).....ILS or LOC Rwy 13<sup>12</sup>  
 ILS or LOC Rwy 36<sup>12</sup>  
 RNAV (GPS) Rwy 13<sup>3</sup>  
 RNAV (GPS) Rwy 18<sup>3</sup>  
 RNAV (GPS) Rwy 31<sup>4</sup>  
 RNAV (GPS) Rwy 36<sup>3</sup>

- NA when local weather not available.
- <sup>1</sup>NA when control tower closed.
- <sup>2</sup>LOC, Category C, 1000-2¼; Category D, 1400-3.
- <sup>3</sup>Category C, 1000-2¼; Category D, 1400-3.
- <sup>4</sup>Categories A, B, 1300-2; Category C, 1300-3; Category D, 1400-3.

**REEDSVILLE, PA**

MIFFLIN  
COUNTY (RVL).....RNAV (GPS) Rwy 6<sup>1</sup>  
 RNAV (GPS) Rwy 24<sup>2</sup>

- NA when local weather not available.
- <sup>1</sup>Categories C, D, 800-2½.
- <sup>2</sup>Categories A, B, C, D, 1100-4.

**ST MARYS, PA**

ST MARYS  
MUNI (OYM).....RNAV (GPS) Rwy 10<sup>1</sup>  
 RNAV (GPS) Rwy 28<sup>2</sup>

- NA when local weather not available.
- <sup>1</sup>Category C, 800-2¼; Category D, 1000-3.
- <sup>2</sup>Categories A, B, 900-2; Category C, 900-2½; Category D, 1000-3.

**SELINGROVE, PA**

PENN VALLEY (SEG).....RNAV (GPS) Rwy 17<sup>1</sup>  
 RNAV (GPS) Rwy 35<sup>2</sup>  
 VOR-A<sup>3</sup>

- <sup>1</sup>Categories A, B, 1000-2; Category C, 1000-3; Category D, 1200-3.
- <sup>2</sup>Categories A, B, 1400-2; Categories C, D, 1400-3.
- <sup>3</sup>Categories A, B, 1000-2.

22 FEB 2024 to 21 MAR 2024

22 FEB 2024 to 21 MAR 2024

NAME ALTERNATE MINIMUMS

**SOMERSET, PA**

SOMERSET COUNTY (2G9).....**LOC Rwy 25**  
NA when local weather not available.  
Categories C, D, 1300-3.

**STATE COLLEGE, PA**

STATE COLLEGE  
RGNL (UNV).....**ILS or LOC Rwy 24<sup>12</sup>**  
**RNAV (GPS) Rwy 6<sup>3</sup>**  
**RNAV (GPS) Rwy 24<sup>23</sup>**

- <sup>1</sup>LOC, Category D, 1400-3.
- <sup>2</sup>NA when local weather not available.
- <sup>3</sup>Category D, 1400-3.

**WASHINGTON, PA**

WASHINGTON  
COUNTY (AFJ).....**RNAV (GPS) Rwy 9<sup>1</sup>**  
**RNAV (GPS) Rwy 27<sup>2</sup>**

- NA when local weather not available.
- <sup>1</sup>Category B, 900-2; Category C, 900-2½;
- Category D, 900-2¾.
- <sup>2</sup>Categories A, B, C, D, 1000-4.

**WELLSBORO, PA**

GRAND CANYON  
RGNL (N38).....**RNAV (GPS) Rwy 10<sup>1</sup>**  
**RNAV (GPS) Rwy 28<sup>2</sup>**

- <sup>1</sup>Categories A, B, 900-2; Category C, 900-2½.
- <sup>2</sup>Category C, 900-2½.

**WHEELING, WV**

WHEELING OHIO  
COUNTY (HLG).....**ILS or LOC Rwy 3<sup>12</sup>**  
**RNAV (GPS) Rwy 3<sup>3</sup>**  
**RNAV (GPS) Rwy 16<sup>3</sup>**  
**RNAV (GPS) Rwy 21<sup>3</sup>**  
**RNAV (GPS) Rwy 34<sup>3</sup>**  
**VOR Rwy 21<sup>3</sup>**

- NA when local weather not available.
- <sup>1</sup>NA when control tower closed.
- <sup>2</sup>LOC, Category D, 800-2¼.
- <sup>3</sup>Category D, 800-2¼.

**WEST CHESTER, PA**

BRANDYWINE  
RGNL (OQN).....**RNAV (GPS) Rwy 27**  
**RNAV (GPS) Y Rwy 9**  
**RNAV (GPS) Z Rwy 9**  
**VOR-A**

NA when local weather not available.

NAME ALTERNATE MINIMUMS

**WILKES-BARRE/SCRANTON, PA**

WILKES-BARRE/SCRANTON  
INTL (AVP).....**ILS or LOC Rwy 4<sup>1</sup>**  
**ILS or LOC Rwy 22<sup>2</sup>**  
**RNAV (GPS) Rwy 4<sup>3</sup>**  
**RNAV (GPS) Rwy 22<sup>3</sup>**

- <sup>1</sup>ILS, LOC, Category A, 900-2;  
Category B, 1100-2; Category C, 1100-3;  
Category D, 1400-3.
- <sup>2</sup>LOC, Category A, 900-2; Category B, 1100-2;  
Category C, 1100-3; Category D, 1400-3.
- <sup>3</sup>Category A, 900-2; Category B, 1100-2;  
Category C, 1100-3; Category D, 1400-3.

**WILLIAMSPORT, PA**

WILLIAMSPORT  
RGNL (IPT).....**ILS or LOC Rwy 27<sup>12</sup>**  
**RNAV (GPS) Rwy 9<sup>3</sup>**  
**RNAV (GPS) Rwy 12<sup>4</sup>**  
**RNAV (GPS) Rwy 27<sup>5</sup>**  
**RNAV (GPS) Rwy 30<sup>6</sup>**

- <sup>1</sup>NA when local control tower closed.
- <sup>2</sup>ILS, LOC, Categories A, B, 1000-2; Category C,  
1400-3; Category D, 1600-3.
- <sup>3</sup>Categories A, B, 1600-2; Category C, 1600-3.
- <sup>4</sup>Category A, 900-2; Category B, 1000-2.
- <sup>5</sup>Categories A, B, 1800-2; Categories C, D, 1800-3;
- <sup>6</sup>Categories A, B, 1500-2.

**YORK, PA**

YORK (THV).....**RNAV (GPS) Rwy 17**  
**RNAV (GPS) Rwy 35**  
NA when local weather not available.  
Category C, 800-2¼.

22 FEB 2024 to 21 MAR 2024

22 FEB 2024 to 21 MAR 2024

# TAKEOFF MINIMUMS, (OBSTACLE) DEPARTURE PROCEDURES, AND DIVERSE VECTOR AREA (RADAR VECTORS)

23334

## INSTRUMENT APPROACH PROCEDURE CHARTS

### IFR TAKEOFF MINIMUMS AND (OBSTACLE) DEPARTURE PROCEDURES

#### Civil Airports and Selected Military Airports

ALL USERS: Airports that have Departure Procedures (DPs) designed specifically to assist pilots in avoiding obstacles during the climb to the minimum enroute altitude, and/or airports that have civil IFR takeoff minimums other than standard, are listed below. Takeoff Minimums and Departure Procedures apply to all runways unless otherwise specified. An entry may also be listed that contains only Takeoff Obstacle Notes. Altitudes, unless otherwise indicated, are minimum altitudes in MSL.

DPs specifically designed for obstacle avoidance are referred to as Obstacle Departure Procedures (ODPs) and are textually described below, or published separately as a graphic procedure. If the ODP is published as a graphic procedure, its name will be listed below, and it can be found in either this volume (civil), or the applicable military volume, as appropriate. Users will recognize graphic obstacle DPs by the term "(OBSTACLE)" included in the procedure title; e.g., TETON TWO (OBSTACLE). If not specifically assigned an ODP, SID, or RADAR vector as part of an IFR clearance, an ODP may be required to be flown for obstacle clearance, even though not specifically stated in the IFR clearance. When doing so in this manner, ATC should be informed when the ODP being used contains a specified route to be flown, restrictions before turning, and/or altitude restrictions.

Some ODPs, which are established solely for obstacle avoidance, require a climb in visual conditions to cross the airport, a fix, or a NAVAID in a specified direction, at or above a specified altitude. These procedures are called Visual Climb Over Airport (VCOA). To ensure safe and efficient operations, the pilot must verbally request approval from ATC to fly the VCOA when requesting their IFR clearance.

At some locations where an ODP has been established, a diverse vector area (DVA) may be created to allow RADAR vectors to be used in lieu of an ODP. DVA information will state that headings will be as assigned by ATC and climb gradients, when applicable, will be published immediately following the specified departure procedure.

Graphic DPs designed by ATC to standardize traffic flows, ensure aircraft separation and enhance capacity are referred to as "Standard Instrument Departures (SIDs)". SIDs also provide obstacle clearance and are published under the appropriate airport section. ATC clearance must be received prior to flying a SID.

CIVIL USERS NOTE: Title 14 Code of Federal Regulations Part 91 prescribes standard takeoff rules and establishes takeoff minimums for certain operators as follows: (1) For aircraft, other than helicopters, having two engines or less – one statute mile visibility. (2) For aircraft having more than two engines – one-half statute mile visibility. (3) For helicopters – one-half statute mile visibility. These standard minima apply in the absence of any different minima listed below.

MILITARY USERS NOTE: Civil (nonstandard) takeoff minima are published below. For military takeoff minima, refer to appropriate service directives.

#### ALLENTOWN, PA

##### ALLENTOWN QUEEN CITY MUNI (XLL)

##### TAKEOFF MINIMUMS AND (OBSTACLE) DEPARTURE PROCEDURES

AMDT 3 10MAR11 (11069) (FAA)

##### TAKEOFF MINIMUMS:

**Rwy 7**, std. w/min. climb of 380' per NM to 2600 or 1600-2½ for climb in visual conditions.

**Rwy 15**, NA.

##### DEPARTURE PROCEDURE:

**Rwy 7**, climb heading 070° to 1800 before turning right, or for climb in visual conditions: cross Allentown Queen City Muni Airport at or above 1900 before proceeding on course.

**Rwy 25**, climbing right turn direct ETX VOR/DME.

**Rwy 33**, climbing left turn direct ETX VOR/DME.

##### TAKEOFF OBSTACLE NOTES:

**Rwy 7**, poles beginning 55' from DER, 322' right of centerline, up to 25' AGL/415' MSL.

**Rwy 25**, fence, trees, and poles beginning 56' from DER, 47' left of centerline, up to 100' AGL/529' MSL.

Trees beginning 294' from DER, 78' right of centerline, up to 100' AGL/452' MSL.

#### LEHIGH VALLEY INTL (ABE)

##### TAKEOFF MINIMUMS AND (OBSTACLE) DEPARTURE PROCEDURES

AMDT 8 30JAN20 (20030) (FAA)

##### DEPARTURE PROCEDURE:

**Rwy 6**, climb on heading 063° to 900 before turning south.

**Rwy 13**, climbing left turn on a heading between 315° CW to 100° from DER, or min. climb of 415' per NM to 1600 for headings 101° through 314°.

**Rwy 24**, climb on heading 243° to 1400 before turning south.

**Rwy 31**, climb on heading 315° to 1400 before proceeding on course.

##### TAKEOFF OBSTACLE NOTES:

**Rwy 6**, lighting 10' from DER, 54' right of centerline, 2' AGL/383' MSL.

Terrain beginning 23' from DER, 388' left of centerline, up to 385' MSL.

Terrain 169' from DER, 472' left of centerline, 386' MSL.

Lighting 174' from DER, 479' left of centerline, 3' AGL/389' MSL.

Building 322' from DER, 287' right of centerline, 19' AGL/396' MSL.

Traverse way 350' from DER, 509' left of centerline, 407' MSL.

Traverse way, fence beginning 378' from DER, 558' left of centerline, up to 409' MSL.

CON'T

# TAKEOFF MINIMUMS, (OBSTACLE) DEPARTURE PROCEDURES, AND DIVERSE VECTOR AREA (RADAR VECTORS)

23334

NE-4



# TAKEOFF MINIMUMS, (OBSTACLE) DEPARTURE PROCEDURES, AND DIVERSE VECTOR AREA (RADAR VECTORS)

23334

## ALLENTOWN, PA (CON'T) LEHIGH VALLEY INTL (ABE) (CON'T)

**Rwy 6 (CON'T)**, tree 1220' from DER, 812' right of centerline, 427' MSL.  
Trees, pole beginning 1242' from DER, 97' left of centerline, up to 441' MSL.  
Trees, poles beginning 1434' from DER, 110' left of centerline, up to 454' MSL.  
Trees beginning 1622' from DER, 152' right of centerline, up to 429' MSL.  
Trees, pole, transmission line beginning 1666' from DER, 91' right of centerline, up to 464' MSL.  
**Rwy 13**, lighting 10' from DER, 55' right of centerline, 2' AGL/381' MSL.  
Pole, 124' from DER, 436' left of centerline, up to 387' MSL.  
Pole, tree beginning 191' from DER, 329' left of centerline, up to 31' AGL/407' MSL.  
Pole 766' from DER, 692' right of centerline, 28' AGL/408' MSL.  
Tree 792' from DER, 632' right of centerline, 411' MSL.  
Tree, pole beginning 851' from DER, 408' right of centerline, up to 413' MSL.  
Tree 1370' from DER, 511' right of centerline, 415' MSL.  
Tree 1598' from DER, 58' right of centerline, 429' MSL.  
Trees beginning 1681' from DER, 25' right of centerline, up to 431' MSL.  
Tree 1769' from DER, 757' right of centerline, 435' MSL.  
Trees beginning 1852' from DER, 11' right of centerline, up to 437' MSL.  
Trees beginning 2140' from DER, 115' left of centerline, up to 441' MSL.  
**Rwy 24**, sign, lighting beginning 4' from DER, 56' right of centerline, up to 2' AGL/396' MSL.  
Lighting 10' from DER, 55' left of centerline, 3' AGL/396' MSL.  
Vertical structure 931' from DER, 667' right of centerline, 423' MSL.  
**Rwy 31**, lighting 9' from DER, 5' left of centerline, 1' AGL/384' MSL.  
Traverse way 31' from DER, 412' right of centerline, 385' MSL.  
Trees beginning 624' from DER, 510' left of centerline, up to 414' MSL.  
Trees beginning 986' from DER, 715' left of centerline, up to 431' MSL.

## ALTOONA, PA ALTOONA/BLAIR COUNTY (AOO)

### TAKEOFF MINIMUMS AND (OBSTACLE) DEPARTURE PROCEDURES AMDT 5 07DEC17 (22027) (FAA)

#### TAKEOFF MINIMUMS:

**Rwy 3**, std. w/min. climb of 270' per NM to 2800 or 1600-3 for climb in visual conditions.  
**Rwy 12**, NA-Obstacles.  
**Rwy 21**, std. w/min. climb of 394' per NM to 3200 or 1600-3 for climb in visual conditions.  
**Rwy 30**, std. w/min. climb of 250' per NM to 3600 or 1600-3 for climb in visual conditions.  
**Note:** climb in visual conditions NA at night.

#### DEPARTURE PROCEDURE:

**Rwy 3**, climb heading 026° to 2800 before proceeding on course.  
**Rwy 21**, climb heading 206° to 3200 before proceeding on course.  
**Rwy 30**, climb heading 298° to 3600 before proceeding on course.

#### VCOA:

Obtain ATC approval for VCOA when requesting IFR clearance. Climb in visual conditions to cross Altoona/Blair County airport at or above 3000 before proceeding on course.

#### TAKEOFF OBSTACLE NOTES:

**Rwy 3**, tree 60' from DER, 449' left of centerline, 1476' MSL.  
Pole 1124' from DER, 742' left of centerline, 50' AGL/1502' MSL.  
Trees beginning 1538' from DER, 563' left of centerline, up to 1541' MSL.  
Tree 3130' from DER, 594' left of centerline, 1554' MSL.  
Tree 4577' from DER, 844' right of centerline, 1584' MSL.  
Tree 4754' from DER, 827' right of centerline, 1598' MSL.  
Tree 5619' from DER, 1199' right of centerline, 1619' MSL.  
Trees beginning 5762' from DER, 1364' right of centerline, up to 1646' MSL.  
Tree 1 NM from DER, 1119' right of centerline, 1648' MSL.  
Trees beginning 1.1 NM from DER, 1129' right of centerline, up to 1658' MSL.  
Trees 1.4 NM from DER, 1628' right of centerline, 200' AGL/1759' MSL.  
**Rwy 21**, tree 30' from DER, 422' left of centerline, 1525' MSL.  
Fence 33' from DER, 249' right of centerline, 4' AGL/1505' MSL.  
Tree, fence beginning 50' from DER, 319' left of centerline, up to 1526' MSL.  
Tree 137' from DER, 371' left of centerline, 1528' MSL.  
Pole, terrain, tree beginning 183' from DER, 265' left of centerline, up to 22' AGL/1536' MSL.  
Tree 881' from DER, 516' right of centerline, 1546' MSL.  
Trees beginning 1077' from DER, 43' right of centerline, up to 1549' MSL.  
Trees beginning 1249' from DER, 557' left of centerline, up to 1557' MSL.  
Trees beginning 1273' from DER, 225' left of centerline, up to 1561' MSL.  
Trees beginning 1774' from DER, 327' left of centerline, up to 1566' MSL.  
Trees beginning 1857' from DER, 277' left of centerline, up to 1570' MSL.  
Trees beginning 1923' from DER, 181' left of centerline, up to 1573' MSL.  
Trees beginning 2174' from DER, 244' left of centerline, up to 1582' MSL.  
Trees beginning 2532' from DER, 196' left of centerline, up to 1596' MSL.  
Trees beginning 2916' from DER, 242' left of centerline, up to 1610' MSL.  
**Rwy 30**, tree 84' from DER, 257' right of centerline, 1480' MSL.  
Tree 92' from DER, 102' left of centerline, 1479' MSL.  
Tree 978' from DER, 316' right of centerline, 1499' MSL.

# TAKEOFF MINIMUMS, (OBSTACLE) DEPARTURE PROCEDURES, AND DIVERSE VECTOR AREA (RADAR VECTORS)

23334

# TAKEOFF MINIMUMS, (OBSTACLE) DEPARTURE PROCEDURES, AND DIVERSE VECTOR AREA (RADAR VECTORS)

23334

## BEAVER FALLS, PA

### BEAVER COUNTY (BVI)

#### TAKEOFF MINIMUMS AND (OBSTACLE) DEPARTURE PROCEDURES

AMDT 2 10MAR11 (11069) (FAA)

#### TAKEOFF OBSTACLE NOTES:

**Rwy 10**, trees beginning 67' from DER, left and right of centerline, up to 64' AGL/1317' MSL.

Fences beginning 124' from DER, 392' left of centerline, up to 10' AGL/1273' MSL.

Bush 326' from DER, 136' right of centerline, 17' AGL/1270' MSL.

Obstruction light on localizer 398' from DER, on centerline, 10' AGL/1263' MSL.

**Rwy 28**, trees beginning 35' from DER, left and right of centerline, up to 100' AGL/ 1319' MSL.

Vegetation beginning 4' from DER, left and right of centerline, up to 33' AGL/1212' MSL.

Bush 173' from DER, 163' right of centerline, 34' AGL/ 1213' MSL.

## BECKLEY, WV

### RALEIGH COUNTY MEML (BKW)

#### TAKEOFF MINIMUMS AND (OBSTACLE) DEPARTURE PROCEDURES

AMDT 5 17NOV11 (21280) (FAA)

#### TAKEOFF MINIMUMS:

**Rwy 10**, 400-2¼ w/min. climb of 350' per NM to 3400, or 1100-3 for climb in visual conditions.

**Rwy 28**, 300-1¼ or std. w/min. climb of 261' per NM to 4000.

#### DEPARTURE PROCEDURE:

**Rwy 1**, climbing left turn heading 350° to 4400 before proceeding on course.

**Rwy 10**, climbing left turn heading 350° to 4700 before proceeding on course, or for climb in visual conditions: cross Raleigh County Meml at or above 3500 before proceeding on course.

**Rwy 19**, climbing right turn heading 330° to 4400 before proceeding on course.

**Rwy 28**, climbing right turn heading 320° to 4400 before proceeding on course.

#### TAKEOFF OBSTACLE NOTES:

**Rwy 1**, trees and terrain beginning 26' from DER, left and right of centerline, up to 100' AGL/2524' MSL.

Pole 718' from DER, 585' right of centerline, 2467' MSL.

**Rwy 10**, trees and terrain beginning 22' from DER, left and right of centerline, up to 100' AGL/2651' MSL.

Bush 32' from DER, 159' right of centerline, 20' AGL/2514' MSL.

Pole 118' from DER, 234' left of centerline, 26' AGL/2510' MSL.

**Rwy 19**, trees and terrain beginning 121' from DER, left and right of centerline, up to 100' AGL/2635' MSL.

**Rwy 28**, trees and bushes beginning 5' from DER, left and right of centerline, up to 100' AGL/2521' MSL.

## BEDFORD, PA

### BEDFORD COUNTY (HMZ)

#### TAKEOFF MINIMUMS AND (OBSTACLE) DEPARTURE PROCEDURES

AMDT 1 07APR11 (11097) (FAA)

#### TAKEOFF MINIMUMS:

**Rwy 14**, std. w/ min. climb of 549' per NM to 2300 or 300-1 w/ min. climb of 369' per NM to 2600 or 2200-3 for climb in visual conditions.

**Rwy 32**, std. w/ min. climb of 403' per NM to 2500 or 500-2½ w/ min. climb of 301' per NM to 3700 or 2200-3 for climb in visual conditions.

#### DEPARTURE PROCEDURE:

**Rwy 14**, climb heading 137° to 2800 before proceeding on course. For climb in visual conditions: cross Bedford County Airport at or above 3200' MSL before proceeding on course.

**Rwy 32**, climb heading 317° to 2600 before proceeding on course. For climb in visual conditions: cross Bedford County airport at or above 3200' MSL before proceeding on course.

#### TAKEOFF OBSTACLE NOTES:

**Rwy 14**, terrain, fence, vehicles on road, and trees beginning 33' from DER, 483' right of centerline, up to 44' AGL/1193' MSL.

Trees 3794' from DER, 1468' left of centerline, up to 70' AGL/1429' MSL.

Trees 4967' from DER, 1607' right of centerline, up to 97' AGL/1376' MSL.

**Rwy 32**, terrain, bush, and trees beginning 22' from DER, 383' left of centerline, up to 88' AGL/1307' MSL.

Trees 3377' from DER, 1253' left of centerline, up to 71' AGL/1330' MSL.

Trees 1.7 NM from DER, 3309' left of centerline, up to 65' AGL/1564' MSL.

Trees 1.9 NM from DER, 2221' left of centerline, up to 67' AGL/1476' MSL.

22 FEB 2024 to 21 MAR 2024

22 FEB 2024 to 21 MAR 2024

# TAKEOFF MINIMUMS, (OBSTACLE) DEPARTURE PROCEDURES, AND DIVERSE VECTOR AREA (RADAR VECTORS)

23334

NE-4

# TAKEOFF MINIMUMS, (OBSTACLE) DEPARTURE PROCEDURES, AND DIVERSE VECTOR AREA (RADAR VECTORS)

23334

## BELLEFONTE, PA

### BELLEFONTE (N96)

#### TAKEOFF MINIMUMS AND (OBSTACLE) DEPARTURE PROCEDURES

AMDT 1 19SEP13 (13262) (FAA)

#### TAKEOFF MINIMUMS:

**Rwy 25**, std. w/min. climb of 267' per NM to 2600, or 1700-3 for climb in visual conditions.

#### DEPARTURE PROCEDURE:

**Rwy 7**, Climb heading 074° to 2900' before proceeding on course.

**Rwy 25**, climb heading 246° to 2600 before proceeding on course or for climb in visual conditions, cross Bellefonte airport at or above 2600 before proceeding on course. When executing VCOA, notify ATC prior to departure.

#### TAKEOFF OBSTACLE NOTES:

**Rwy 7**, buildings beginning 42' from DER, 293' left of centerline, up to 15' AGL/1062' MSL.

Tree 130' from DER, 365' left of centerline, 28' AGL/1075' MSL.

Pole 135' from DER, 516' right of centerline, 30' AGL/1080' MSL.

Buildings beginning 86' from DER, 340' right of centerline, up to 17' AGL/1084' MSL.

Tree 134' from DER, 286' right of centerline, 42' AGL/1096' MSL.

Pole 75' from DER, 433' right of centerline, 33' AGL/1096' MSL.

Trees beginning 731' from DER, 432' left of centerline, up to 108' AGL/1139' MSL.

Tree 231' from DER, 448' right of centerline, 60' AGL/1110' MSL.

**Rwy 25**, trees beginning 59' from DER, 373' right of centerline, up to 89' AGL/1143' MSL.

Pole 67' from DER, 172' right of centerline 26' AGL/1080' MSL.

Poles beginning 89' from DER, 277' left of centerline, up to 26' AGL/1096' MSL.

Buildings beginning 92' from DER, 524' left of centerline, 30' AGL/1112' MSL.

Trees beginning 190' from DER, 236' right of centerline, up to 80' AGL/1126' MSL.

Vehicle or road 351' from DER, 169' left of centerline, 15' AGL/1093' MSL.

Buildings beginning 449' from DER, 527' left of centerline, 30' AGL/1113' MSL.

Trees beginning 398' from DER, 199' right of centerline, up to 84' AGL/1111' MSL.

Trees 538' from DER, 633' left of centerline, up to 60' AGL/1143' MSL.

Vehicle on road 757' from DER, 670' left of centerline, 15' AGL/1102' MSL.

Trees beginning 760' from DER, 146' right of centerline, up to 52' AGL/1100' MSL.

Buildings beginning 1075' from DER, 550' left of centerline, up to 30' AGL/1112' MSL.

Trees beginning 1375' from DER, 697' left of centerline, up to 77' AGL/1150' MSL.

Trees beginning 2277' from DER, 319' left of centerline, up to 65' AGL/1178' MSL.

Trees beginning 2394' from DER, 35' right of centerline, up to 97' AGL/1137' MSL.

Trees beginning 3737' from DER 187' left of centerline, up to 61' AGL/1201' MSL.

## BERKELEY SPRINGS, WV

### POTOMAC AIRPARK (W35)

#### TAKEOFF MINIMUMS AND (OBSTACLE) DEPARTURE PROCEDURES

AMDT 2 20JUN19 (19171) (FAA)

#### TAKEOFF MINIMUMS:

**Rwy 11**, 400-1 ¾ w/min. climb of 370' per NM to 2800, or 1700-3 for VCOA.

**Rwy 29**, 500-1½ w/min. climb of 400' per NM to 2600, or 1700-3 for VCOA.

#### DEPARTURE PROCEDURE:

**Rwy 11**, climb heading 110° to 1100 before proceeding on course.

**Rwy 29**, climb heading 290° to 1700 then climbing left turn to 5000 and on the HGR VOR R-270 to HGR VOR before proceeding on course.

#### VCOA:

All runways, obtain ATC approval for VCOA when requesting IFR clearance. Climb in visual conditions to cross Potomac Airpark airport at or above 2200 before proceeding on course.

#### TAKEOFF OBSTACLE NOTES:

**Rwy 11**, vegetation 17' from DER, 203' right of centerline, 416' MSL.

Tree 30' from DER, 331' right of centerline, 483' MSL.

Vegetation 30' from DER, 21' left of centerline, 416' MSL.

Trees beginning 43' from DER, 44' right of centerline, up to 94' AGL/502' MSL.

Tree 95' from DER, 115' left of centerline, 432' MSL.

Tree 102' from DER, 223' left of centerline, 467' MSL.

Trees beginning 193' from DER, 16' left of centerline, up to 470' MSL.

Tree 417' from DER, 443' right of centerline, 520' MSL.

Trees beginning 435' from DER, 150' right of centerline, up to 544' MSL.

Tree 543' from DER, 251' left of centerline, 480' MSL.

Trees beginning 604' from DER, 4' left of centerline, up to 500' MSL.

Trees beginning 617' from DER, 22' right of centerline, up to 572' MSL.

Trees beginning 789' from DER, 24' left of centerline, up to 518' MSL.

Trees beginning 960' from DER, 27' right of centerline, up to 614' MSL.

Trees beginning 1334' from DER, 13' right of centerline, up to 631' MSL.

Trees beginning 1358' from DER, 18' left of centerline, up to 521' MSL.

Trees beginning 1472' from DER, 423' right of centerline, up to 646' MSL.

Tree, pole beginning 1544' from DER, 208' right of centerline, up to 650' MSL.

Tree, pole, vegetation beginning 1775' from DER, 105' right of centerline, up to 658' MSL.

Tree, vegetation beginning 1981' from DER, 34' right of centerline, up to 664' MSL.

Trees beginning 2031' from DER, 7' left of centerline, up to 530' MSL.

Tree, vegetation, building beginning 2151' from DER, 1' right of centerline, up to 668' MSL.

Trees beginning 3321' from DER, 4' right of centerline, up to 669' MSL.

CONT

# TAKEOFF MINIMUMS, (OBSTACLE) DEPARTURE PROCEDURES, AND DIVERSE VECTOR AREA (RADAR VECTORS)

23334

NE-4

# TAKEOFF MINIMUMS, (OBSTACLE) DEPARTURE PROCEDURES, AND DIVERSE VECTOR AREA (RADAR VECTORS)

23334

## BERKELEY SPRINGS, WV (CON'T) POTOMAC AIRPARK (W35) (CON'T)

**Rwy 29 (CON'T)**, tree, building beginning 5998' from DER, 9' left of centerline, up to 621' MSL.  
 Trees beginning 1 NM from DER, 446' left of centerline, up to 632' MSL.  
 Trees beginning 1 NM from DER, 139' left of centerline, up to 645' MSL.  
 Trees beginning 1 NM from DER, 337' left of centerline, up to 647' MSL.  
 Tree beginning 1 NM from DER, 46' left of centerline, up to 650' MSL.  
 Tree beginning 1 NM from DER, 5' left of centerline, up to 675' MSL.  
 Tree 1.1 NM from DER, 1033' left of centerline, 684' MSL.  
 Trees beginning 1.1 NM from DER, 234' left of centerline, up to 692' MSL.  
 Trees beginning 1.1 NM from DER, 718' left of centerline, up to 697' MSL.  
 Tree beginning 1.1 NM from DER, 120' left of centerline, up to 100' AGL/701' MSL.  
 Tree, pole beginning 1.1 NM from DER, 76' right of centerline, up to 100' AGL/753' MSL.  
 Tree beginning 1.1 NM from DER, 1' left of centerline, up to 100' AGL/737' MSL.  
 Tree beginning 1.2 NM from DER, 357' right of centerline, up to 100' AGL/770' MSL.  
 Trees beginning 1.2 NM from DER, 423' right of centerline, up to 772' MSL.  
 Tree beginning 1.2 NM from DER, 23' left of centerline, up to 100' AGL/747' MSL.  
 Trees beginning 1.2 NM from DER, 81' right of centerline, up to 786' MSL.  
 Tree beginning 1.2 NM from DER, 81' right of centerline, up to 100' AGL/796' MSL.  
 Tree beginning 1.2 NM from DER, 1' left of centerline, up to 100' AGL/763' MSL.  
 Tree beginning 1.2 NM from DER, 1256' right of centerline, up to 100' AGL/809' MSL.  
 Tree, terrain+veg beginning 1.2 NM from DER, 173' right of centerline, up to 809' MSL.  
 Trees beginning 1.3 NM from DER, 302' right of centerline, up to 811' MSL.  
 Tree, building, pole beginning 1.3 NM from DER, 10' left of centerline, up to 100' AGL/776' MSL.  
 Tree, terrain+veg beginning 1.3 NM from DER, 1' right of centerline, up to 772' MSL.  
 Tree, vehicle on traverse way beginning 1.3 NM from DER, 252' right of centerline, up to 823' MSL.  
 Tree, vehicle on traverse way, building, pole, fence, vegetation beginning 1.4 NM from DER, 1' right of centerline, up to 101' AGL/825' MSL.  
 Tree beginning 1.8 NM from DER, 2543' left of centerline, up to 100' AGL/793' MSL.  
 Tree beginning 1.8 NM from DER, 1674' left of centerline, up to 100' AGL/812' MSL.  
 Pole, tree beginning 1.9 NM from DER, 1390' left of centerline, up to 100' AGL/852' MSL.  
 Tree beginning 2 NM from DER, 2848' left of centerline, up to 100' AGL/875' MSL.  
 Vehicle on traverse way, tree beginning 2 NM from DER, 388' left of centerline, up to 100' AGL/881' MSL.

## BLOOMSBURG, PA

### BLOOMSBURG MUNI (N13)

#### TAKEOFF MINIMUMS AND (OBSTACLE) DEPARTURE PROCEDURES AMDT 2 28APR16 (16119) (FAA)

##### TAKEOFF MINIMUMS:

**Rwy 9**, std. w/min. climb of 660' per NM to 1400 or 2100-3 for climb in visual conditions.  
**Rwy 27**, std. w/min. climb of 300' per NM to 1400 or 2100-3 for climb in visual conditions.

##### DEPARTURE PROCEDURE:

**Rwy 9**, Climbing left turn heading 059° to 2200 before proceeding on course. Do not exceed 180 KIAS until established on 059° heading.

**Rwy 27**, Climb heading 254° to 2200 before proceeding on course.

##### TAKEOFF OBSTACLE NOTES:

**Rwy 9**, Trees beginning 51' from DER, 6' right of centerline, up to 642' MSL.  
 Trees beginning 475' from DER, 24' left of centerline, up to 599' MSL.  
 Grd 64' from DER, 34' right of centerline, 487' MSL.  
 Vehicle on road 176' from DER, 112' right of centerline, 15' AGL/488' MSL.  
 Poles beginning 191' from DER, 432' left of centerline, up to 44' AGL/528' MSL.  
 Building 335' from DER, 568' left of centerline, 501' MSL.  
 Parking lots beginning 629' from DER, 652' left of centerline, up to 503' MSL.  
 Terrain 1503' from DER, 164' right of centerline, 524' MSL.  
**Rwy 27**, tower 4520' from DER, 596' right of centerline, 150' AGL/632' MSL.  
 Buildings beginning 35' from DER, 327' left of centerline, up to 506' MSL.  
 Vehicles in parking lots beginning 48' from DER, 238' right of centerline, up to 496' MSL.  
 Pole 151' from DER, 238' right of centerline, 8' AGL/499' MSL.  
 Poles beginning 210' from DER, 493' left of centerline, up to 521' MSL.  
 Vehicle on road 279' from DER, 210' right of centerline, 15' AGL/494' MSL.  
 Trees beginning 50' from DER, 50' left of centerline, up to 579' MSL.  
 Trees beginning 559' from DER, 96' right of centerline, up to 566' MSL.  
 Stack 5202' from DER, 660' right of centerline, 175' AGL/661' MSL.  
 Chimney/smokestack 5199' from DER, 661' right of centerline, 659' MSL.

22 FEB 2024 to 21 MAR 2024

22 FEB 2024 to 21 MAR 2024

# TAKEOFF MINIMUMS, (OBSTACLE) DEPARTURE PROCEDURES, AND DIVERSE VECTOR AREA (RADAR VECTORS)

23334

# TAKEOFF MINIMUMS, (OBSTACLE) DEPARTURE PROCEDURES, AND DIVERSE VECTOR AREA (RADAR VECTORS)

23334

## BERKELEY SPRINGS, WV (CON'T) POTOMAC AIRPARK (W35) (CON'T)

**Rwy 11 (CON'T)**, trees beginning 3368' from DER, 403' right of centerline, up to 673' MSL.

Trees beginning 3418' from DER, 928' right of centerline, up to 692' MSL.

Trees beginning 3472' from DER, 254' right of centerline, up to 698' MSL.

Trees beginning 3564' from DER, 70' right of centerline, up to 702' MSL.

Trees beginning 3610' from DER, 348' right of centerline, up to 712' MSL.

Tree 3736' from DER, 1450' right of centerline, 713' MSL.

Trees beginning 3738' from DER, 502' right of centerline, up to 715' MSL.

Tree 3826' from DER, 1196' right of centerline, 724' MSL.

Tree, beginning 3833' from DER, 393' right of centerline, up to 729' MSL.

Trees beginning 4064' from DER, 1126' left of centerline, up to 571' MSL.

Trees beginning 4135' from DER, 684' right of centerline, up to 732' MSL.

Trees beginning 4157' from DER, 119' left of centerline, up to 581' MSL.

Trees beginning 4188' from DER, 431' right of centerline, up to 734' MSL.

Trees beginning 4250' from DER, 653' right of centerline, up to 736' MSL.

Trees beginning 4331' from DER, 477' right of centerline, up to 738' MSL.

Trees beginning 4377' from DER, 865' right of centerline, up to 744' MSL.

Trees beginning 4377' from DER, 1457' left of centerline, up to 582' MSL.

Trees beginning 4439' from DER, 540' right of centerline, up to 748' MSL.

Trees beginning 4463' from DER, 1396' left of centerline, up to 603' MSL.

Tree, vehicle on traverse way beginning 4487' from DER, 535' right of centerline, up to 766' MSL.

Trees beginning 4579' from DER, 1471' left of centerline, up to 608' MSL.

Trees beginning 4673' from DER, 1453' left of centerline, up to 633' MSL.

Trees beginning 4769' from DER, 1379' left of centerline, up to 649' MSL.

Tree, vehicle on traverse way beginning 4811' from DER, 678' right of centerline, up to 773' MSL.

Tree, terrain, vehicle on traverse way, pole, building beginning 4917' from DER, 731' right of centerline, up to 778' MSL.

Tree, tower beginning 1.3 NM from DER, 1405' right of centerline, up to 106' AGL/785' MSL.

Trees beginning 1.5 NM from DER, 2402' left of centerline, up to 658' MSL.

Tree 1.5 NM from DER, 2630' left of centerline, 684' MSL.

Trees beginning 1.5 NM from DER, 2046' left of centerline, up to 695' MSL.

Trees beginning 1.5 NM from DER, 2392' left of centerline, up to 705' MSL.

Trees beginning 1.5 NM from DER, 1944' left of centerline, up to 708' MSL.

Trees beginning 1.5 NM from DER, 1979' left of centerline, up to 728' MSL.

Tree, pole beginning 1.6 NM from DER, 2181' left of centerline, up to 738' MSL.

Trees beginning 1.6 NM from DER, 2106' left of centerline, up to 68' AGL/758' MSL.

Tree 2.2 NM from DER, 3177' left of centerline, 776' MSL.

Tree 2.3 NM from DER, 3840' left of centerline, 84' AGL/803' MSL.

**Rwy 29**, tree 16' from DER, 357' right of centerline, 475' MSL.

Tree, vehicle on traverse way, vegetation beginning 33' from DER, 22' right of centerline, up to 488' MSL.

Tree, vehicle on traverse way beginning 62' from DER, 56' left of centerline, up to 500' MSL.

Trees beginning 186' from DER, 269' left of centerline, up to 94' AGL/512' MSL.

Tree, vehicle on traverse way beginning 201' from DER, 242' left of centerline, up to 517' MSL.

Trees beginning 356' from DER, 534' right of centerline, up to 493' MSL.

Trees beginning 530' from DER, 521' right of centerline, up to 496' MSL.

Tree, vehicle on traverse way, pole beginning 576' from DER, 9' left of centerline, up to 528' MSL.

Trees beginning 719' from DER, 120' right of centerline, up to 501' MSL.

Trees beginning 864' from DER, 31' right of centerline, up to 512' MSL.

Trees beginning 2033' from DER, 78' right of centerline, up to 521' MSL.

Tree, pole beginning 2357' from DER, 76' right of centerline, up to 533' MSL.

Trees beginning 3728' from DER, 259' right of centerline, up to 540' MSL.

Tree 3747' from DER, 862' right of centerline, 541' MSL.

Trees beginning 3766' from DER, 213' right of centerline, up to 558' MSL.

Trees beginning 3859' from DER, 435' left of centerline, up to 532' MSL.

Trees beginning 4009' from DER, 525' right of centerline, up to 561' MSL.

Terrain+veg, tree beginning 4136' from DER, 386' right of centerline, up to 100' AGL/570' MSL.

Trees beginning 4319' from DER, 21' right of centerline, up to 573' MSL.

Terrain+veg, tree beginning 4880' from DER, 709' right of centerline, up to 100' AGL/589' MSL.

Trees beginning 5017' from DER, 324' right of centerline, up to 593' MSL.

Trees beginning 5081' from DER, 746' right of centerline, up to 601' MSL.

Trees beginning 5090' from DER, 41' right of centerline, up to 612' MSL.

Tree, pole beginning 5172' from DER, 135' right of centerline, up to 614' MSL.

Trees beginning 5176' from DER, 59' left of centerline, up to 555' MSL.

Tree, building, pole, terrain beginning 5253' from DER, 40' right of centerline, up to 625' MSL.

Trees beginning 5267' from DER, 13' left of centerline, up to 568' MSL.

Trees beginning 5338' from DER, 119' left of centerline, up to 583' MSL.

Tree, pole beginning 5501' from DER, 1049' right of centerline, up to 636' MSL.

Pole, tree beginning 5532' from DER, 184' left of centerline, up to 600' MSL.

Tree, vehicle on traverse way beginning 5559' from DER, 176' right of centerline, up to 651' MSL.

Pole, tree beginning 5622' from DER, 340' left of centerline, up to 602' MSL.

Tree, vehicle on traverse way beginning 5647' from DER, 127' right of centerline, up to 683' MSL.

Tree, pole beginning 5699' from DER, 39' left of centerline, up to 616' MSL.

Tank, pole, tree, vehicle on traverse way beginning 5742' from DER, 440' right of centerline, up to 80' AGL/689' MSL.

Tree 5799' from DER, 1453' right of centerline, 693' MSL.

Tree, vehicle on traverse way building, pole, stack beginning 5811' from DER, on centerline, up to 712' MSL.

**CON'T**

# TAKEOFF MINIMUMS, (OBSTACLE) DEPARTURE PROCEDURES, AND DIVERSE VECTOR AREA (RADAR VECTORS)

23334

# TAKEOFF MINIMUMS, (OBSTACLE) DEPARTURE PROCEDURES, AND DIVERSE VECTOR AREA (RADAR VECTORS)

23334

## BLUEFIELD, WV

### MERCER COUNTY (BLF)

TAKEOFF MINIMUMS AND (OBSTACLE) DEPARTURE PROCEDURES  
AMDT 4 15JAN09 (09015) (FAA)

TAKEOFF MINIMUMS:

**Rwy 23**, 400-2¼ or std. with a min. climb of 238' per NM to 3300.

DEPARTURE PROCEDURE:

**Rwy 5**, climb heading 049° to 3900 before turning south.

**Rwy 23**, climbing right turn via BLF R-270 to 4500 before proceeding on course.

TAKEOFF OBSTACLE NOTES:

**Rwy 5**, trees beginning 14' from DER, 370' left of centerline, up to 100' AGL/2939' MSL.

Trees beginning 15' from DER, 391' right of centerline, up to 100' AGL/2959' MSL.

**Rwy 23**, trees beginning at DER, 258' left of centerline, up to 100' AGL/2939' MSL.

Trees beginning 140' from DER, 74' right of centerline, up to 100' AGL/3159' MSL.

## BRADFORD, PA

### BRADFORD RGNL (BFD)

TAKEOFF MINIMUMS AND (OBSTACLE) DEPARTURE PROCEDURES  
ORIG 27SEP07 (22223) (FAA)

TAKEOFF OBSTACLE NOTES:

**Rwy 5**, fence 448' from DER, 305' left of centerline, 19' AGL/2158' MSL.

Fence 462' from DER, 299' right of centerline, 19' AGL/2158' MSL.

Trees beginning 234' from DER, 70' left of centerline, up to 75' AGL/2242' MSL.

Trees beginning 67' from DER, 227' right of centerline, up to 87' AGL/2226' MSL.

**Rwy 14**, trees beginning 26' from DER, 263' left of centerline, up to 16' AGL/2115' MSL.

Tree 2427' from DER, 918' right of centerline, 79' AGL/2198' MSL.

**Rwy 23**, trees beginning 53' from DER, 145' left of centerline, up to 82' AGL/2240' MSL.

Trees beginning 272' from DER, 220' right of centerline, up to 86' AGL/2225' MSL.

**Rwy 32**, trees beginning 1018' from DER, 399' left of centerline, up to 102' AGL/2169' MSL.

Trees beginning 138' from DER, 292' right of centerline, up to 86' AGL/2205' MSL.

## BUCKHANNON, WV

### UPSHUR COUNTY RGNL (W22)

TAKEOFF MINIMUMS AND (OBSTACLE) DEPARTURE PROCEDURES  
ORIG 10JUN04 (04162) (FAA)

TAKEOFF MINIMUMS:

**Rwy 29**, 400-1¼ or std. with a min. climb of 420' per NM to 2100.

DEPARTURE PROCEDURE:

**Rwy 11**, climb via heading 105° to 2300 before proceeding on course.

TAKEOFF OBSTACLE NOTES:

**Rwy 11**, trees 798' from DER, 179' right of centerline, 100' AGL/1679' MSL.

Trees 2665' from DER, 842' left of centerline, 100' AGL/1719' MSL.

Trees 4799' from DER, 1724' right of centerline, 100' AGL/1779' MSL.

**Rwy 29**, trees 1 NM from DER, 565' right of centerline, 100' AGL/1959' MSL.

## BUTLER, PA

### PITTSBURGH/BUTLER RGNL (BTP)

TAKEOFF MINIMUMS AND (OBSTACLE) DEPARTURE PROCEDURES  
AMDT 4 07DEC17 (17341) (FAA)

TAKEOFF MINIMUMS:

**Rwy 8**, 300-1 or std. w/min. climb of 461' per NM to 1600.

TAKEOFF OBSTACLE NOTES:

**Rwy 8**, tree 18' from DER, 218' right of centerline, 1265' MSL.

Pole 68' from DER, 469' left of centerline, 24' AGL/1245' MSL.

Tree 99' from DER, 478' left of centerline, 1246' MSL.

Tree 147' from DER, 441' right of centerline, 1278' MSL.

Pole 183' from DER, 372' left of centerline, 36' AGL/1248' MSL.

Trees beginning 196' from DER, 69' left of centerline, up to 1270' MSL.

Trees beginning 202' from DER, 327' right of centerline, up to 1285' MSL.

Trees beginning 343' from DER, 13' right of centerline, up to 1288' MSL.

Trees beginning 748' from DER, 26' left of centerline, up to 1278' MSL.

Trees beginning 977' from DER, 391' left of centerline, up to 1281' MSL.

Trees beginning 1056' from DER, 15' left of centerline, up to 1302' MSL.

Trees beginning 1197' from DER, 288' left of centerline, up to 1319' MSL.

Trees beginning 1231' from DER, 167' left of centerline, up to 1325' MSL.

Trees beginning 1326' from DER, 167' right of centerline, up to 1302' MSL.

Trees beginning 1422' from DER, 282' right of centerline, up to 1310' MSL.

Trees beginning 2359' from DER, 325' right of centerline, up to 1316' MSL.

Trees beginning 2423' from DER, 658' left of centerline, up to 1350' MSL.

Tree 2532' from DER, 435' right of centerline, 1330' MSL.

Trees beginning 2554' from DER, 389' right of centerline, up to 1337' MSL.

Trees beginning 2626' from DER, 106' left of centerline, up to 1352' MSL.

CON'T

# TAKEOFF MINIMUMS, (OBSTACLE) DEPARTURE PROCEDURES, AND DIVERSE VECTOR AREA (RADAR VECTORS)

23334

NE-4

# TAKEOFF MINIMUMS, (OBSTACLE) DEPARTURE PROCEDURES, AND DIVERSE VECTOR AREA (RADAR VECTORS)

23334

## BUTLER, PA (CON'T)

### PITTSBURGH/BUTLER RGNL (BTP) (CON'T)

**Rwy 8 (CON'T)**, trees beginning 2704' from DER, 393' right of centerline, up to 1347' MSL.

Trees beginning 2935' from DER, 733' right of centerline, up to 1354' MSL.

Trees beginning 3471' from DER, 626' right of centerline, up to 1357' MSL.

Tree 3721' from DER, 601' right of centerline, 1359' MSL.

Trees beginning 3771' from DER, 516' right of centerline, up to 1373' MSL.

Tree 3810' from DER, 647' right of centerline, 1377' MSL.

Trees beginning 3827' from DER, 411' right of centerline, up to 1404' MSL.

Trees beginning 4118' from DER, 893' right of centerline, up to 1445' MSL.

Trees beginning 4173' from DER, 417' right of centerline, up to 1482' MSL.

Tree 4255' from DER, 1554' right of centerline, 1488' MSL.

Trees beginning 4256' from DER, 708' right of centerline, up to 1491' MSL.

Trees beginning 4641' from DER, 1460' right of centerline, up to 1399' MSL.

**Rwy 26**, general utility 13' from DER, 117' right of centerline, 3' AGL/1229' MSL.

Trees, beginning 1001' from DER, 282' left of centerline, up to 1280' MSL.

Tree 1756' from DER, 432' left of centerline, 1287' MSL.

Tree 3239' from DER, 54' left of centerline, 1309' MSL.

Tree 3357' from DER, 32' right of centerline, 1314' MSL.

## CARLISLE, PA

### CARLISLE (N94)

#### TAKEOFF MINIMUMS AND (OBSTACLE) DEPARTURE PROCEDURES

AMDT 2 06MAR14 (14065) (FAA)

##### DEPARTURE PROCEDURE:

**Rwy 10**, climb heading 102° to 1400 before turning right.

**Rwy 28**, climb heading 282° to 1900 before proceeding on course.

##### TAKEOFF OBSTACLE NOTES:

**Rwy 10**, vehicles on road, beginning 14' from DER, left and right of centerline, up to 15' AGL/534' MSL.

Poles beginning 196' from DER, left and right of centerline, up to 30' AGL/550' MSL.

Building 351' from DER, 121' left of centerline, 25' AGL/535' MSL.

**Rwy 28**, vehicles on road, abeam DER, 336' right of centerline, up to 15' AGL/524' MSL.

Trees 322' from DER, 96' right of centerline, up to 100' AGL/609' MSL.

Trees 2484' from DER, 439' left of centerline, up to 100' AGL/609' MSL.

## CHAMBERSBURG, PA

### FRANKLIN COUNTY RGNL (N68)

#### TAKEOFF MINIMUMS AND (OBSTACLE) DEPARTURE PROCEDURES

AMDT 4 24MAR22 (22083) (FAA)

##### TAKEOFF MINIMUMS:

**Rwy 24**, std. w/min. climb of 215' per NM to 1400 or 1900-3 for VCOA.

##### DEPARTURE PROCEDURE:

**Rwy 6**, climb on heading 059° to 2300 before proceeding on course.

**Rwy 24**, climb on heading 239° to 2000 before proceeding on course.

##### VCOA:

**Rwy 24**, obtain ATC approval for VCOA when requesting IFR clearance. Climb in visual conditions to cross Franklin County

Rgnl airport at or above 2400 before proceeding on course.

##### TAKEOFF OBSTACLE NOTES:

**Rwy 6**, trees beginning 150' from DER, 339' right of centerline, up to 725' MSL.

Trees, pole beginning 324' from DER, 95' right of centerline, up to 726' MSL.

Pole, tree beginning 657' from DER, 189' left of centerline, up to 55' AGL/722' MSL.

Trees beginning 979' from DER, 11' right of centerline, up to 731' MSL.

Tree 1102' from DER, 66' left of centerline, 725' MSL.

Trees beginning 1156' from DER, 10' left of centerline, up to 729' MSL.

Tree 1414' from DER, 283' left of centerline, 733' MSL.

Trees beginning 1414' from DER, 218' left of centerline, up to 737' MSL.

Trees beginning 1719' from DER, 337' right of centerline, up to 736' MSL.

Tree 2111' from DER, 535' left of centerline, 739' MSL.

Tree 2163' from DER, 245' right of centerline, 740' MSL.

Tree 2247' from DER, 576' left of centerline, 742' MSL.

Tree 2652' from DER, 866' left of centerline, 753' MSL.

Pole 4744' from DER, 1225' left of centerline, 120' AGL/804' MSL.

**Rwy 24**, vehicle on road 154' from DER, 497' right of centerline, 694' MSL.

Tree 4183' from DER, 1206' right of centerline, 793' MSL.

22 FEB 2024 to 21 MAR 2024

22 FEB 2024 to 21 MAR 2024

# TAKEOFF MINIMUMS, (OBSTACLE) DEPARTURE PROCEDURES, AND DIVERSE VECTOR AREA (RADAR VECTORS)

23334

# TAKEOFF MINIMUMS, (OBSTACLE) DEPARTURE PROCEDURES, AND DIVERSE VECTOR AREA (RADAR VECTORS)

23334

## CHARLESTON, WV

### WEST VIRGINIA INTL YEAGER (CRW)

#### TAKEOFF MINIMUMS AND (OBSTACLE) DEPARTURE PROCEDURES

AMDT 10 10OCT19 (22083) (FAA)

##### TAKEOFF MINIMUMS:

**Rwy 5**, 300-2¼ or std. w/min. climb of 285' per NM to 1200.

##### DEPARTURE PROCEDURE:

**Rwy 23**, climb heading 233° to 1400 before turning left.

##### TAKEOFF OBSTACLE NOTES:

**Rwy 5**, lighting 7' from DER, 55' right of centerline, 2' AGL/896' MSL.  
Trees 17' from DER, 64' left of centerline, 896' MSL.  
Trees beginning 2793' from DER, 247' right of centerline, up to 971' MSL.  
Tree 3063' from DER, 471' right of centerline, 976' MSL.  
Trees beginning 3149' from DER, 365' right of centerline, up to 983' MSL.  
Trees beginning 3185' from DER, 66' right of centerline, up to 994' MSL.  
Tree 3374' from DER, 10' left of centerline, 987' MSL.  
Tree, terrain beginning 3522' from DER, 249' right of centerline, up to 998' MSL.  
Trees beginning 3571' from DER, 35' left of centerline, up to 1006' MSL.  
Tree 3580' from DER, 605' right of centerline, 999' MSL.  
Tree, terrain, pole beginning 3627' from DER, 10' right of centerline, up to 1007' MSL.  
Trees beginning 3702' from DER, 361' left of centerline, up to 1009' MSL.  
Trees beginning 3730' from DER, 214' left of centerline, up to 1010' MSL.  
Tree 3904' from DER, 68' left of centerline, 1012' MSL.  
Trees beginning 3931' from DER, 205' left of centerline, up to 1017' MSL.  
Trees beginning 3968' from DER, 57' right of centerline, up to 1010' MSL.  
Tree, terrain beginning 4060' from DER, 28' left of centerline, up to 1025' MSL.  
Tree, terrain beginning 4339' from DER, 38' left of centerline, up to 1029' MSL.  
Trees beginning 4450' from DER, 1513' right of centerline, up to 1018' MSL.  
Tree, terrain beginning 4518' from DER, 144' left of centerline, up to 1031' MSL.  
Tree, terrain beginning 4584' from DER, 253' left of centerline, up to 1032' MSL.  
Tree 4594' from DER, 35' right of centerline, 1019' MSL.  
Tree 4679' from DER, 292' left of centerline, 1035' MSL.  
Tree 4726' from DER, 458' left of centerline, 1040' MSL.  
Trees beginning 4758' from DER, 87' left of centerline, up to 1041' MSL.  
Tree 4935' from DER, 1279' right of centerline, 1021' MSL.  
Tree 5050' from DER, 973' right of centerline, 1031' MSL.  
Trees beginning 5217' from DER, 566' right of centerline, up to 1045' MSL.  
Antenna 2.2 NM from DER, 2891' left of centerline, 1238' MSL.  
**Rwy 23**, pole 114' from DER, 185' left of centerline, 17' AGL/951' MSL.  
Pole 121' from DER, 271' right of centerline, 17' AGL/950' MSL.  
Tree 4457' from DER, 1692' left of centerline, 1071' MSL.  
Tree 4747' from DER, 1667' left of centerline, 1077' MSL.

## CLARION, PA

### CLARION COUNTY (AXQ)

#### TAKEOFF MINIMUMS AND (OBSTACLE) DEPARTURE PROCEDURES

ORIG 02AUG07 (07219) (FAA)

##### TAKEOFF MINIMUMS:

**Rwy 24**, 200-1½ or std. w/ min. climb of 211' per NM to 1700.

##### TAKEOFF OBSTACLE NOTES:

**Rwy 6**, multiple trees beginning 697' from DER, 311' left of centerline, up to 100' AGL/1519' MSL.  
Multiple trees beginning 1006' from DER, 47' right of centerline, up to 100' AGL/1529' MSL.  
Building 2942' from DER, 964' right of centerline, 60' AGL/1539' MSL.  
**Rwy 24**, multiple trees beginning 792' from DER, 27' left of centerline, up to 100' AGL/1539' MSL.  
Multiple trees beginning 806' from DER, 147' right of centerline, up to 100' AGL/1539' MSL.  
Tree 1.1 NM from DER, 2010' right of centerline, 100' AGL/1619' MSL.

## CLARKSBURG, WV

### NORTH CENTRAL WEST VIRGINIA (CKB)

#### TAKEOFF MINIMUMS AND (OBSTACLE) DEPARTURE PROCEDURES

AMDT 6 20SEP12 (12264) (FAA)

##### TAKEOFF MINIMUMS:

**Rwy 3**, 300-1¾ or std. w/ min. climb of 402' per NM to 1500.

**Rwy 21**, 400-2¾ or std. w/ min. climb of 447' per NM to 1600.

##### DEPARTURE PROCEDURE:

**Rwy 3**, climb heading 031° to 2000 before proceeding on course.

**Rwy 21**, climb heading 211° to 1800 before proceeding on course.

##### TAKEOFF OBSTACLE NOTES:

**Rwy 3**, trees beginning 348' from DER, 584' left of centerline, up to 100' AGL/1279' MSL.  
Trees beginning 5135' from DER, 33' left of centerline, up to 75' AGL/1374' MSL.  
Tree 1042' from DER, 659' right of centerline, 100' AGL/1319' MSL.  
Trees beginning 2454' from DER, 659' right of centerline, up to 100' AGL/1374' MSL.  
Fence 2875' from DER, 756' right of centerline, 10' AGL/ 1316' MSL.  
CON'T

# TAKEOFF MINIMUMS, (OBSTACLE) DEPARTURE PROCEDURES, AND DIVERSE VECTOR AREA (RADAR VECTORS)

23334

NE-4



# TAKEOFF MINIMUMS, (OBSTACLE) DEPARTURE PROCEDURES, AND DIVERSE VECTOR AREA (RADAR VECTORS)

23334

## CLARSBURG, WV (CON'T)

### NORTH CENTRAL WEST VIRGINIA (CKB) (CON'T)

**Rwy 3 (CON'T)**, terrain 2720' from DER, 622' right of centerline, 1370' MSL.

**Rwy 21**, bush 12' from DER, 258' left of centerline, 5' AGL/1184' MSL.

Tree 571' from DER, 533' left of centerline, 86' AGL/1226' MSL.

Trees 4880' from DER, 90' left of centerline, up to 100' AGL/1335' MSL.

## CLEARFIELD, PA

### CLEARFIELD-LAWRENCE (FIG)

#### TAKEOFF MINIMUMS AND (OBSTACLE) DEPARTURE PROCEDURES

AMDT 3 20SEP12 (12264) (FAA)

##### TAKEOFF MINIMUMS:

**Rwy 30**, std. w/min. climb of 342' per NM to 3500 or 1900-3 for climb in visual conditions.

##### DEPARTURE PROCEDURE:

**Rwy 12**, climb heading 110° to 2500 before proceeding on course.

**Rwy 30**, climb heading 299° to 2700 before proceeding on course, or for climb in visual conditions cross Clearfield-Lawrence airport at or above 3300 before proceeding on course. When executing VCOA, notify ATC prior to departure.

##### TAKEOFF OBSTACLE NOTES:

**Rwy 12**, trees beginning 166' from DER, left and right of centerline, up to 100' AGL/ 1635' MSL.

Tower, 2.73 NM from DER, 4881' right of centerline, 422' AGL/ 2032' MSL.

**Rwy 30**, airplane on taxiway 7' from DER, 131' left of centerline, up to 15' AGL/ 1534' MSL.

Trees beginning 53' from DER, left and right of centerline, up to 100' AGL/2135' MSL.

Vehicles on roadway beginning 241' from DER, left and right of centerline, up to 15' AGL/ 1534' MSL.

Towers beginning 2.32 NM from DER, 760' left and right of centerline, up to 611' AGL/ 2996' MSL.

## COATESVILLE, PA

### CHESTER COUNTY G. O. CARLSON (MQS)

#### TAKEOFF MINIMUMS AND (OBSTACLE) DEPARTURE PROCEDURES

ORIG 31JUL08 (08213) (FAA)

##### TAKEOFF OBSTACLE NOTES:

**Rwy 11**, tree 342' from DER, 592' right of centerline, 90' AGL/680' MSL.

Trees beginning 1135' from DER, 549' left of centerline, up to 87' AGL/696' MSL.

**Rwy 29**, tree 281' from DER, 325' left of centerline, 7' AGL/646' MSL.

Obstruction light on poles beginning 418' from DER, 308' right of centerline, up to 40' AGL/690' MSL.

Antenna on buildings beginning 506' from DER, 208' right of centerline, up to 23' AGL/692' MSL.

Trees beginning 1048' from DER, 277' right of centerline, up to 62' AGL/731' MSL.

Multiple poles beginning 1723' from DER, 238' right of centerline, up to 34' AGL/703' MSL.

## CONNELLSVILLE, PA

### JOSEPH A HARDY CONNELLSVILLE (VVS)

#### TAKEOFF MINIMUMS AND (OBSTACLE) DEPARTURE PROCEDURES

AMDT 1 20SEP12 (12264) (FAA)

##### TAKEOFF MINIMUMS:

**Rwy 14**, NA - Obstacles.

##### DEPARTURE PROCEDURE:

**Rwy 5**, climb heading 049° to 3100 before proceeding on course.

**Rwy 23**, climb heading 229° to 3200 before proceeding on course.

**Rwy 32**, climb heading 319° to 3000 before proceeding on course.

##### TAKEOFF OBSTACLE NOTES:

**Rwy 5**, bldg 203' from DER, 270' right of centerline, 24' AGL/1274' MSL.

LOC 329' from DER, 2' right of centerline, 13' AGL/1273' MSL.

Road 8' from DER, 476' right of centerline, 1273' MSL.

Trees beginning 68' from DER, 17' left of centerline, up to 100' AGL/1386' MSL.

Trees beginning 117' from DER, 4' right of centerline, up to 100' AGL/1385' MSL.

**Rwy 23**, tree 620' from DER, 642' left of centerline, 100' AGL/1258' MSL.

**Rwy 32**, trees beginning 1004' from DER, 129' left of centerline, 100' AGL/1263' MSL.

Trees beginning 1004' from DER, 11' right of centerline, up to 100' AGL/1306' MSL.

Pole 1292' from DER, 734' right of centerline, 33' AGL/1273' MSL.

Sign 36' from DER, 200' left of centerline, 2' AGL/1229' MSL.

## CORRY, PA

### CORRY-LAWRENCE (8G2)

#### TAKEOFF MINIMUMS AND (OBSTACLE) DEPARTURE PROCEDURES

ORIG-A 05MAY11 (11125) (FAA)

##### TAKEOFF OBSTACLE NOTES:

**Rwy 14**, terrain, tank, pole, and trees beginning 54' from DER, 300' left of centerline, up to 66' AGL/1835' MSL.

Pole and trees beginning 169' from DER, 285' right of centerline, up to 49' AGL/1808' MSL.

**Rwy 32**, Trees beginning 35' from DER, 87' left of centerline, up to 60' AGL/1749' MSL.

Trees beginning 178' from DER, 14' right of centerline, up to 67' AGL/1756' MSL.

# TAKEOFF MINIMUMS, (OBSTACLE) DEPARTURE PROCEDURES, AND DIVERSE VECTOR AREA (RADAR VECTORS)

23334

NE-4

# TAKEOFF MINIMUMS, (OBSTACLE) DEPARTURE PROCEDURES, AND DIVERSE VECTOR AREA (RADAR VECTORS)

23334

## DANVILLE, PA

DANVILLE (8N8)

TAKEOFF MINIMUMS AND (OBSTACLE) DEPARTURE PROCEDURES

ORIG 31MAY12 (12152) (FAA)

TAKEOFF MINIMUMS:

**Rwy 9**, std. w/min. climb of 370' per NM to 2000, or 1700-3 for climb in visual conditions.**Rwy 27**, std. w/min. climb of 280' per NM to 2400, or 1700-3 for climb in visual conditions.

DEPARTURE PROCEDURE:

**Rwy 9**, climb heading 088° to 2000 before proceeding on course or for climb in visual conditions cross Danville Airport at or above 1900 before proceeding on course. When executing VCOA, notify ATC prior to departure.**Rwy 27**, climb heading 268° to 2400 before proceeding on course or for climb in visual conditions cross Danville Airport at or above 1900 before proceeding on course. When executing VCOA, notify ATC prior to departure.

TAKEOFF OBSTACLE NOTES:

**Rwy 9**, trees beginning 665' from DER, 554' right of centerline, up to 100' AGL/699' MSL.

Trees beginning 769' from DER, 326' left of centerline, up to 100' AGL/659' MSL.

**Rwy 27**, trees beginning 1332' from DER, 274' right of centerline, up to 100' AGL/619' MSL.

Trees beginning 968' from DER, 136' left of centerline, up to 100' AGL/639' MSL.

Pole beginning 1145' from DER, 174' left of centerline, 58' AGL/588' MSL.

## DOYLESTOWN, PA

DOYLESTOWN (DYL)

TAKEOFF MINIMUMS AND (OBSTACLE) DEPARTURE PROCEDURES

AMDT 2 25NOV04 (04330) (FAA)

TAKEOFF OBSTACLE NOTES:

**Rwy 5**, terrain and trees 246' from DER, 457' right of centerline, 60' AGL/460' MSL.**Rwy 23**, terrain and tree 1498' from DER, 764' left of centerline, 100' AGL/460' MSL.

Terrain and trees 2701' from DER, 44' left of centerline, 100' AGL/480' MSL.

## DUBOIS, PA

DUBOIS RGNL (DUJ)

TAKEOFF MINIMUMS AND (OBSTACLE) DEPARTURE PROCEDURES

AMDT 2 03JUN10 (10154) (FAA)

TAKEOFF OBSTACLE NOTES:

**Rwy 7**, wind sock 31' from DER, 452' left of centerline, 29' AGL/1834' MSL.

Tree 1608' from DER, 698' right of centerline, up to 99' AGL/1859' MSL.

**Rwy 25**, wind sock and trees beginning 97' from DER, 300' right of centerline, up to 74' AGL/1854' MSL.

Buildings and trees beginning 164' from DER, 254' left of centerline, up to 92' AGL/1872' MSL.

## EASTON, PA

BRADEN AIRPARK (N43)

TAKEOFF MINIMUMS AND (OBSTACLE) DEPARTURE PROCEDURES

AMDT 1 21OCT10 (10294) (FAA)

TAKEOFF MINIMUMS:

**Rwy 18**, 400-2% or std. w/ min. climb of 203' per NM to 900, or alternatively, with standard takeoff minimums and a normal 200'/NM climb gradient, takeoff must occur no later than 1200' prior to DER.**Rwy 36**, standard with minimum climb of 452' per NM to 1300 or 600-3 with minimum climb of 256' per NM to 2600 or 1300-2% for climb in visual conditions.

DEPARTURE PROCEDURE:

**Rwy 18**, climb heading 179° to 1100 before proceeding on course.**Rwy 36**, for climb in visual conditions: cross Braden Airpark at or above 1500 before proceeding on course.

TAKEOFF OBSTACLE NOTES:

**Rwy 18**, trees beginning 571' from DER, 453' left of centerline, up to 100' AGL/499' MSL.

Trees beginning 1366' from DER, 539' right of centerline, up to 100' AGL/499' MSL.

**Rwy 36**, vehicles on road, 50' from DER, on centerline, up to 15' AGL/414' MSL.

Trees beginning 986' from DER, 40' left of centerline, up to 100' AGL/539' MSL.

Building and trees beginning 153' from DER, 89' right of centerline, up to 100' AGL/ 539' MSL.

## EBENSBURG, PA

EBENSBURG (9G8)

TAKEOFF MINIMUMS AND (OBSTACLE) DEPARTURE PROCEDURES

AMDT 2A 17SEP15 (15260) (FAA)

TAKEOFF MINIMUMS:

**Rwy 7**, 300-1½ or std. w/ min. climb of 350' per NM to 2500.**Rwy 11U, 29U**, NA-Environmental.

TAKEOFF OBSTACLE NOTES:

**Rwy 25**, numerous trees beginning 632' from DER, 245' left of centerline, up to 100' AGL/2179' MSL.

Numerous trees beginning 759' from DER, 477' right of centerline, up to 100' AGL/2159' MSL.

**Rwy 7**, numerous trees beginning 245' from DER, 476' right of centerline, up to 100' AGL/2279' MSL.

Numerous trees beginning 696' from DER, 273' left of centerline, up to 100' AGL/2389' MSL.

Stack 1.1 NM from DER, 1571' right of centerline, 192' AGL/2352' MSL.

Tower 1.17 NM from DER, 1529' right of centerline, 198' AGL/2348' MSL.

Vehicle on highway, 487' from DER, 180' right of centerline, 19' AGL/2138' MSL.

# TAKEOFF MINIMUMS, (OBSTACLE) DEPARTURE PROCEDURES, AND DIVERSE VECTOR AREA (RADAR VECTORS)

23334

**TAKEOFF MINIMUMS, (OBSTACLE) DEPARTURE PROCEDURES, AND**

  
**DIVERSE VECTOR AREA (RADAR VECTORS)**

23334

**ELKINS, WV**

ELKINS/RANDOLPH COUNTY (JENNINGS RANDOLPH FLD) (EKN)

TAKEOFF MINIMUMS AND (OBSTACLE) DEPARTURE PROCEDURES

AMDT 4 03NOV22 (22307) (FAA)

DEPARTURE PROCEDURE:

Use ELKINS DEPARTURE.

TAKEOFF OBSTACLE NOTES:

**Rwy 23**, trees beginning 4' from DER, 270' right of centerline, up to 2028' MSL.  
 Trees, pole beginning 132' from DER, 224' left of centerline, up to 2021' MSL.  
 Trees, pole beginning 544' from DER, 146' left of centerline, up to 2049' MSL.  
 Tower 860' from DER, 185' left of centerline, 88' AGL/2059' MSL.  
 Trees, building, elevators beginning 904' from DER, 281' left of centerline, up to 2066' MSL.  
 Tree 1.1 NM from DER, 2195' right of centerline, 2179' MSL.  
 Trees beginning 1.1 NM from DER, 1744' right of centerline, up to 2210' MSL.  
 Trees beginning 1.2 NM from DER, 1786' right of centerline, up to 2213' MSL.  
 Trees beginning 1.2 NM from DER, 1978' right of centerline, up to 2223' MSL.  
 Tree 1.2 NM from DER, 2157' right of centerline, 2229' MSL.  
 Trees beginning 1.2 NM from DER, 1980' right of centerline, up to 2292' MSL.  
 Trees beginning 1.5 NM from DER, 1394' right of centerline, up to 2358' MSL.  
 Trees beginning 1.5 NM from DER, 2802' right of centerline, up to 2364' MSL.  
 Trees beginning 1.5 NM from DER, 1180' right of centerline, up to 2383' MSL.  
 Trees beginning 1.5 NM from DER, 2201' right of centerline, up to 2425' MSL.  
 Tree 1.5 NM from DER, 1646' right of centerline, 2439' MSL.  
 Trees beginning 1.5 NM from DER, 1379' right of centerline, up to 2478' MSL.  
 Trees beginning 1.6 NM from DER, 1997' right of centerline, up to 2532' MSL.  
 Trees beginning 1.6 NM from DER, 700' right of centerline, up to 2579' MSL.  
 Trees beginning 1.6 NM from DER, 794' right of centerline, up to 2592' MSL.  
 Trees beginning 1.6 NM from DER, 5' right of centerline, up to 2602' MSL.  
 Tree 2.1 NM from DER, 367' left of centerline, 2306' MSL.  
 Trees beginning 2.2 NM from DER, 1007' left of centerline, up to 2454' MSL.  
 Trees beginning 2.2 NM from DER, 475' left of centerline, up to 2463' MSL.  
 Tree 2.2 NM from DER, 422' left of centerline, 2530' MSL.  
 Tree 2.2 NM from DER, 1043' left of centerline, 2562' MSL.  
 Trees beginning 2.2 NM from DER, 251' left of centerline, up to 2563' MSL.

**ERIE, PA**

ERIE INTL/TOM RIDGE FLD (ERI)

TAKEOFF MINIMUMS AND (OBSTACLE) DEPARTURE PROCEDURES

AMDT 6A 27JAN22 (22027) (FAA)

TAKEOFF MINIMUMS:

**Rwy 20**, 300-1¼ or std. w/min. climb of 331' per NM to 1100.

DEPARTURE PROCEDURE:

**Rwy 2**, climb heading 020° to 1300 before turning right.**Rwy 6**, climb heading 064° to 1900 before turning right.**Rwy 20**, climb heading 200° to 1700 before turning left.**Rwy 24**, climb heading 244° to 1400 before turning left.

TAKEOFF OBSTACLE NOTES:

**Rwy 2**, vehicles on road, building, trees and poles beginning 31' from DER, 2' left of centerline, up to 131' AGL/821' MSL.  
 Trees, fence, vehicles on road and poles beginning 74' from DER, 1' right of centerline, up to 107' AGL/817' MSL.  
**Rwy 6**, trees beginning 381' from DER, 336' right of centerline, up to 100' AGL/832' MSL.  
 Trees beginning 1360' from DER, 678' left of centerline, up to 98' AGL/818' MSL.  
**Rwy 20**, trees, railroads, buildings and poles beginning 41' from DER, 3' left of centerline, up to 105' AGL/883' MSL.  
 Fence, bush, railroads, trees, buildings, poles and steeple beginning 130' from DER, 1' right of centerline, up to 112' AGL/869' MSL.  
 Trees and poles beginning 4411' from DER, left and right of centerline, up to 103' AGL/883' MSL.  
 Tree 1 NM from DER, 694' right of centerline, up to 143' AGL/983' MSL.  
 Tree 1.35 NM from DER, 2559' right of centerline, up to 94' AGL/944' MSL.  
**Rwy 24**, railroad, pole and trees beginning 11' from DER, 325' left of centerline, up to 67' AGL/797' MSL.  
 Rod on building, antenna and trees beginning 135' from DER, 250' right of centerline, up to 111' AGL/834' MSL.  
 Trees beginning 2568' from DER, 226' left of centerline, up to 97' AGL/827' MSL.

22 FEB 2024 to 21 MAR 2024

22 FEB 2024 to 21 MAR 2024

**TAKEOFF MINIMUMS, (OBSTACLE) DEPARTURE PROCEDURES, AND**

  
**DIVERSE VECTOR AREA (RADAR VECTORS)**

23334

**TAKEOFF MINIMUMS, (OBSTACLE) DEPARTURE PROCEDURES, AND**

  
**DIVERSE VECTOR AREA (RADAR VECTORS)**

23334

**FACTORYVILLE, PA**

SEAMANS FLD (9N3)

TAKEOFF MINIMUMS AND (OBSTACLE) DEPARTURE PROCEDURES

AMDT 3 31JUL08 (21280) (FAA)

TAKEOFF MINIMUMS:

**Rwy 4**, 400-2½ or std. w/min. climb of 221' per NM to 1700.

DEPARTURE PROCEDURE:

**Rwy 4**, climb heading 036° to 1700 before proceeding on course.**Rwy 22**, climb heading 216° to 2900 before proceeding on course.

TAKEOFF OBSTACLE NOTES:

**Rwy 4**, trees beginning 1134' from DER, 720' right of centerline, up to 65' AGL/1264' MSL.

Trees beginning 1.82 NM from DER, 774' left of centerline, up to 100' AGL/1499' MSL.

**FAIRMONT, WV**

FAIRMONT MUNI-FRANKMAN FLD (4G7)

TAKEOFF MINIMUMS AND (OBSTACLE) DEPARTURE PROCEDURES

AMDT 6A 25APR19 (21280) (FAA)

TAKEOFF MINIMUMS:

**Rwy 5**, 500-3 or std. w/min. climb of 729' per NM to 1800.**Rwy 23**, 500-2¼ w/min. climb of 274' per NM to 1900 or std. w/min. climb of 442' per NM to 1500, or 1300-3 for VCOA.

DEPARTURE PROCEDURE:

**Rwy 5**, climb heading 045° to 1800 before proceeding on course.**Rwy 23**, climb heading 225° to 1700 before proceeding on course.

VCOA:

**Rwy 23**, obtain ATC approval for VCOA when requesting IFR clearance. Climb in visual conditions to cross Fairmont Muni-Frankman Fld at or above 2200 before proceeding on course.

TAKEOFF OBSTACLE NOTES:

**Rwy 5**, trees beginning 3' from DER, 67' right of centerline, up to 52' AGL/1035' MSL.

Tree 11' from DER, 377' left of centerline, 61' AGL/1033' MSL.

Trees beginning 33' from DER, 309' left of centerline, up to 51' AGL/1036' MSL.

Trees beginning 129' from DER, 190' left of centerline, up to 62' AGL/1041' MSL.

Tree and pole beginning 403' from DER, 126' right of centerline, up to 62' AGL/1045' MSL.

Tree 565' from DER, 213' right of centerline, 78' AGL/1048' MSL.

Tree and pole beginning 572' from DER, 151' right of centerline, up to 70' AGL/1050' MSL.

Trees beginning 622' from DER, 211' right of centerline, up to 85' AGL/1062' MSL.

Trees beginning 739' from DER, 240' right of centerline, up to 101' AGL/1076' MSL.

Tree 1494' from DER, 608' left of centerline, 105' AGL/1067' MSL.

Tree 1784' from DER, 974' right of centerline, 58' AGL/1161' MSL.

Tree 1817' from DER, 943' right of centerline, 62' AGL/1164' MSL.

Trees beginning 1848' from DER, 698' right of centerline, up to 73' AGL/1181' MSL.

Tower 1.7 NM from DER, 725' right of centerline, 228' AGL/1477' MSL.

**Rwy 23**, pole, fence, building, sign, tree, terrain and vegetation beginning 4' from DER, 24' left of centerline, up to 47' AGL/1086' MSL.

Pole 12' from DER, 102' right of centerline, 3' AGL/1038' MSL.

Pole 60' from DER, 81' right of centerline, 3' AGL/1042' MSL.

Tree and pole beginning 89' from DER, 96' right of centerline, up to 64' AGL/1078' MSL.

Tree and pole beginning 134' from DER, 110' right of centerline, up to 81' AGL/1100' MSL.

Tree and building, fence, pole, terrain beginning 189' from DER, 42' right of centerline, up to 76' AGL/1102' MSL.

Tree, pole, terrain and building beginning 318' from DER, 11' left of centerline, up to 51' AGL/1099' MSL.

Tree, building and pole beginning 428' from DER, 2' right of centerline, up to 84' AGL/1122' MSL.

Tree, building and pole beginning 585' from DER, 7' left of centerline, up to 89' AGL/1120' MSL.

Tree, pole and building beginning 632' from DER, 1' left of centerline, up to 100' AGL/1127' MSL.

Trees beginning 3368' from DER, 284' right of centerline, up to 1183' MSL.

Terrain 4084' from DER, 684' left of centerline, 1177' MSL.

Tree and terrain beginning 4237' from DER, 137' left of centerline, up to 71' AGL/1183' MSL.

Terrain beginning 4287' from DER, 649' left of centerline, up to 1184' MSL.

Tree, terrain and building beginning 4381' from DER, 329' left of centerline, up to 46' AGL/1274' MSL.

22 FEB 2024 to 21 MAR 2024

22 FEB 2024 to 21 MAR 2024

**TAKEOFF MINIMUMS, (OBSTACLE) DEPARTURE PROCEDURES, AND**

  
**DIVERSE VECTOR AREA (RADAR VECTORS)**

23334

# TAKEOFF MINIMUMS, (OBSTACLE) DEPARTURE PROCEDURES, AND DIVERSE VECTOR AREA (RADAR VECTORS)

23334

## FINLEYVILLE, PA

FINLEYVILLE AIRPARK (G05)

TAKEOFF MINIMUMS AND (OBSTACLE) DEPARTURE PROCEDURES

ORIG 12OCT17 (17285) (FAA)

DEPARTURE PROCEDURE:

**Rwy 32**, climb heading 318° to 1800 before turning right.

TAKEOFF OBSTACLE NOTES:

**Rwy 14**, trees beginning 28' from DER, 102' left of centerline, 1319' MSL.

Trees beginning 30' from DER, 124' right of centerline, 1319' MSL.

Tree 584' from DER, 54' left of centerline, up to 1319' MSL.

Trees beginning 1521' from DER, 129' left of centerline, 1339' MSL.

**Rwy 32**, trees beginning 26' from DER, 227' right of centerline, 1299' MSL.

Trees 274' from DER, crossing centerline, 1299' MSL.

## FRANKLIN, PA

VENANGO RGNL (FKL)

TAKEOFF MINIMUMS AND (OBSTACLE) DEPARTURE PROCEDURES

AMD T 3 30SEP04 (04274) (FAA)

DEPARTURE PROCEDURE:

**Rwy 3**, climb via heading 027° to 2000 before proceeding on course.**Rwy 12**, climb via heading 116° to 2000 before proceeding on course.**Rwy 21**, climb via heading 207° to 2000 before proceeding on course.**Rwy 30**, climb via heading 296° to 2000 before proceeding on course.

TAKEOFF OBSTACLE NOTES:

**Rwy 3**, tree 638' from DER, 528' right of centerline, 34' AGL/1553' MSL.

Tree 2547' from DER, 697' right of centerline, 78' AGL/1597' MSL.

**Rwy 12**, tank 1027' from DER, 660' left of centerline, 92' AGL/1612' MSL.

Tree 1123' from DER, 504' left of centerline, 81' AGL/1600' MSL.

Tree 800' from DER, 369' right of centerline, 71' AGL/1571' MSL.

**Rwy 21**, multiple trees beginning 573' from DER, 191' to 679' right of centerline, up to 81' AGL/1599' MSL.

Multiple trees beginning 264' from DER, 326' to 749' left of centerline, up to 68' AGL/1597' MSL.

Sign 2474' from DER, 30' right of centerline, 94' AGL/1606' MSL.

Pole 1295' from DER, 530' left of centerline, 47' AGL/1567' MSL.

## FREESPORT, PA

MCVILLE (6P7)

TAKEOFF MINIMUMS AND (OBSTACLE) DEPARTURE PROCEDURES

ORIG 08NOV18 (18312) (FAA)

TAKEOFF MINIMUMS:

**Rwy 14**, 400-2½ or std. w/min. climb of 430' per NM to 1700.**Rwy 32**, 500-2½ or std. w/min. climb of 330' per NM to 1600.

DEPARTURE PROCEDURE:

**Rwy 32**, climb heading 325° to 1600 before turning right.

TAKEOFF OBSTACLE NOTES:

**Rwy 14**, trees beginning 1.3 NM from DER, 341' left of centerline, 100' AGL/1400' MSL.

Tree 1.4 NM from DER, 466' left of centerline, 100' AGL/1501' MSL.

**Rwy 32**, tree 1.4 NM from DER, 1029' left of centerline, 100' AGL/1300' MSL.

Trees beginning 1.6 NM from DER, 2540' left of centerline, up to 100' AGL/1440' MSL.

Tree 1.8 NM from DER, 1547' right of centerline, 100' AGL/1390' MSL.

Tower 2.3 NM from DER, 939' right of centerline, 261' AGL/1524' MSL.

## GETTYSBURG, PA

GETTYSBURG RGNL (W05)

TAKEOFF MINIMUMS AND (OBSTACLE) DEPARTURE PROCEDURES

ORIG-A 20AUG15 (15232) (FAA)

TAKEOFF MINIMUMS:

**Rwy 6**, NA, obstacles.**Rwy 24**, std. w/ min. climb of 310' per NM to 1900, or 1500-2½ for climb in visual conditions.

DEPARTURE PROCEDURE:

**Rwy 24**, climb heading 241° to 1900 before proceeding on course.

VCOA: Obtain ATC approval for climb in visual conditions when requesting IFR clearance. Climb in visual conditions to cross Gettysburg Regional airport at or above 1900 before proceeding on course.

TAKEOFF OBSTACLE NOTES:

**Rwy 24**, vehicle on road 350' from DER, 61' left of centerline 17' AGL/576' MSL.

Trees beginning 273' from DER, 214' right of centerline, up to 100' AGL/639' MSL.

# TAKEOFF MINIMUMS, (OBSTACLE) DEPARTURE PROCEDURES, AND DIVERSE VECTOR AREA (RADAR VECTORS)

23334

NE-4

**TAKEOFF MINIMUMS, (OBSTACLE) DEPARTURE PROCEDURES, AND**

  
**DIVERSE VECTOR AREA (RADAR VECTORS)**

23334

**GREENVILLE, PA**

GREENVILLE MUNI (4G1)

TAKEOFF MINIMUMS AND (OBSTACLE) DEPARTURE PROCEDURES

ORIG 12NOV15 (15316) (FAA)

TAKEOFF MINIMUMS:

**Rwy 5, 23**, NA-Environmental.

DEPARTURE PROCEDURE:

**Rwy 33**, climb heading 330° to 1600 before turning right.

TAKEOFF OBSTACLE NOTES:

**Rwy 15**, vehicles on road 220' from DER, left and right of centerline, 15' AGL/1214' MSL.

Trees 381' from DER, 480' right of centerline, up to 100' AGL/1309' MSL.

Trees 1381' from DER, left and right of centerline, up to 100' AGL/1239' MSL.

**Rwy 33**, trees 184' from DER, 278' right of centerline, 100' AGL/1259' MSL.

Trees 1923' from DER, left and right of centerline, 100' AGL/1229' MSL.

**GROVE CITY, PA**

GROVE CITY (29D)

TAKEOFF MINIMUMS AND (OBSTACLE) DEPARTURE PROCEDURES

AMDT 4A 05DEC19 (19339) (FAA)

TAKEOFF OBSTACLE NOTES:

**Rwy 10**, tree 15' from DER, 98' left of centerline, 1311' MSL.

Tree 68' from DER, 129' right of centerline, 1308' MSL.

Trees, buildings, poles beginning 72' from DER, 223' right of centerline, up to 1357' MSL.

Tree 174' from DER, 389' left of centerline, 1352' MSL.

Trees, pole beginning 284' from DER, 100' left of centerline, up to 1356' MSL.

Trees, poles, sign beginning 792' from DER, 201' right of centerline, up to 1361' MSL.

Trees beginning 1819' from DER, 35' left of centerline, up to 1359' MSL.

Tree 2062' from DER, 642' right of centerline, 1362' MSL.

**Rwy 28**, terrain 4' from DER, 85' right of centerline, 1373' MSL.

Tree 22' from DER, 91' left of centerline, 1373' MSL.

Fence 78' from DER, 321' right of centerline, 14' AGL/1387' MSL.

Trees, terrain beginning 126' from DER, 100' left of centerline, up to 1436' MSL.

Building, tree, pole beginning 165' from DER, 223' right of centerline, up to 21' AGL/1404' MSL.

Tree 376' from DER, 600' right of centerline, 1457' MSL.

Trees beginning 539' from DER, 598' right of centerline, up to 1462' MSL.

Trees, vehicles on road, poles, transmission line beginning 589' from DER, 34' left of centerline, up to 1465' MSL.

Trees, vehicles on road, beginning 837' from DER, 35' right of centerline, up to 1464' MSL.

Trees, poles, building, transmission line beginning 1015' from DER, 54' right of centerline, up to 1486' MSL.

Trees, poles, vehicles on road beginning 1106' from DER, 6' left of centerline, up to 1467' MSL.

Trees, transmission line, pole beginning 1504' from DER, 28' left of centerline, up to 1489' MSL.

Trees beginning 2430' from DER, 644' right of centerline, up to 1493' MSL.

Tree 2534' from DER, 892' right of centerline, 1495' MSL.

Trees beginning 2552' from DER, 564' right of centerline, up to 1502' MSL.

Trees beginning 2656' from DER, 727' right of centerline, up to 1506' MSL.

Trees beginning 2686' from DER, 1' right of centerline, up to 1512' MSL.

Trees beginning 4050' from DER, 914' left of centerline, up to 1490' MSL.

22 FEB 2024 to 21 MAR 2024

22 FEB 2024 to 21 MAR 2024

**TAKEOFF MINIMUMS, (OBSTACLE) DEPARTURE PROCEDURES, AND**

  
**DIVERSE VECTOR AREA (RADAR VECTORS)**

23334

# TAKEOFF MINIMUMS, (OBSTACLE) DEPARTURE PROCEDURES, AND DIVERSE VECTOR AREA (RADAR VECTORS)

23334

## HARRISBURG, PA

### HARRISBURG/CAPITAL CITY (CXY)

#### TAKEOFF MINIMUMS AND (OBSTACLE) DEPARTURE PROCEDURES

AMDT 5 10SEP20 (20254) (FAA)

##### TAKEOFF MINIMUMS:

**Rwy 8**, 400-2¼ or std. w/min. climb of 305' per NM to 600.

**Rwy 12**, std. w/min. climb of 377' per NM to 1300, or 700-3 w/min. climb of 351' per NM to 1300.

**Rwy 26**, 400-2½ or std. w/min. climb of 353' per NM to 800.

**Rwy 30**, NA-Obstacles.

##### DEPARTURE PROCEDURE:

**Rwy 8**, climb on heading 082° to 1300 before proceeding on course.

**Rwy 12**, climb on heading 128° to 1400 before proceeding on course

**Rwy 26**, climb on heading 262° to 1500 before proceeding on course.

##### TAKEOFF OBSTACLE NOTES:

**Rwy 8**, vehicle on traverse way, lighting beginning 5' from DER, 53' left of centerline, up to 354' MSL.

Lighting 10' from DER, 56' right of centerline, 2' AGL/348' MSL.

Tree, building, pole beginning 100' from DER, 67' right of centerline, up to 50' AGL/398' MSL.

Pole 225' from DER, 501' left of centerline, 24' AGL/359' MSL.

Tree, pole beginning 247' from DER, 21' left of centerline, up to 376' MSL.

Trees beginning 4587' from DER, 1355' left of centerline, up to 54' AGL/496' MSL.

Tree 4657' from DER, 1242' left of centerline, 508' MSL.

Trees beginning 4689' from DER, 764' left of centerline, up to 518' MSL.

Trees beginning 4853' from DER, 909' left of centerline, up to 71' AGL/525' MSL.

Trees beginning 5010' from DER, 430' left of centerline, up to 96' AGL/537' MSL.

Tree, pole, spire, building beginning 5987' from DER, 37' left of centerline, up to 92' AGL/559' MSL.

Tree 1 NM from DER, 410' right of centerline, 509' MSL.

Tree 1 NM from DER, 434' right of centerline, 510' MSL.

Pole, tree beginning 1 NM from DER, 140' right of centerline, up to 76' AGL/516' MSL.

Tree 1 NM from DER, 207' right of centerline, 533' MSL.

Trees beginning 1 NM from DER, 10' right of centerline, up to 540' MSL.

Tree, pole beginning 1.1 NM from DER, 316' left of centerline, up to 60' AGL/562' MSL.

Tree, building beginning 1.1 NM from DER, 35' left of centerline, up to 563' MSL.

Trees beginning 1.1 NM from DER, 185' left of centerline, up to 568' MSL.

Tree 1.2 NM from DER, 2274' left of centerline, 63' AGL/569' MSL.

Tree, pole beginning 1.2 NM from DER, 1136' left of centerline, up to 62' AGL/572' MSL.

Trees beginning 1.2 NM from DER, 496' left of centerline, up to 574' MSL.

Trees beginning 1.3 NM from DER, 679' left of centerline, up to 76' AGL/584' MSL.

Trees beginning 1.3 NM from DER, 753' left of centerline, up to 586' MSL.

Tree 1.3 NM from DER, 795' left of centerline, 94' AGL/588' MSL.

Trees beginning 1.3 NM from DER, 540' left of centerline, up to 598' MSL.

Trees beginning 1.4 NM from DER, 323' left of centerline, up to 84' AGL/599' MSL.

Trees beginning 1.5 NM from DER, 2083' left of centerline, up to 603' MSL.

Trees beginning 1.5 NM from DER, 1715' left of centerline, up to 608' MSL.

Trees beginning 1.7 NM from DER, 490' left of centerline, up to 613' MSL.

Tower 1.7 NM from DER, 628' left of centerline, 89' AGL/615' MSL.

Tree 1.7 NM from DER, 25' left of centerline, 624' MSL.

Tree 1.7 NM from DER, 223' right of centerline, 627' MSL.

Trees beginning 1.7 NM from DER, 143' right of centerline, up to 638' MSL.

Trees beginning 1.7 NM from DER, 4' right of centerline, up to 640' MSL.

Tree 1.7 NM from DER, 25' left of centerline, 632' MSL.

Trees beginning 1.8 NM from DER, 135' right of centerline, up to 647' MSL.

**Rwy 12**, vehicle on traverse way, terrain, poles beginning 13' from DER, 261' right of centerline, up to 373' MSL.

Sign 43' from DER, 250' left of centerline, 5' AGL/347' MSL.

Terrain 331' from DER, 197' left of centerline, 352' MSL.

Vegetation, terrain, fence beginning 340' from DER, 105' left of centerline, up to 362' MSL.

Trees, terrain, poles, fence beginning 443' from DER, 82' left of centerline, up to 67' AGL/412' MSL.

Buildings, fence beginning 472' from DER, 22' right of centerline, up to 42' AGL/391' MSL.

Trees, fence, poles, buildings beginning 697' from DER, 19' left of centerline, up to 80' AGL/436' MSL.

Trees, buildings beginning 859' from DER, 18' right of centerline, up to 392' MSL.

Trees, poles beginning 1186' from DER, 119' left of centerline, up to 445' MSL.

Building beginning 1293' from DER, 273' right of centerline, up to 37' AGL/395' MSL.

Poles, trees, stack, buildings, spire beginning 1406' from DER, 100' left of centerline, up to 72' AGL/451' MSL.

Pole 2147' from DER, 110' right of centerline, 43' AGL/403' MSL.

Pole 2220' from DER, 112' right of centerline, 45' AGL/404' MSL.

Trees, buildings beginning 2929' from DER, 145' left of centerline, up to 461' MSL.

**Rwy 26**, terrain, vehicle on traverse way beginning 3' from DER, 151' left of centerline, up to 337' MSL.

Trees beginning 524' from DER, 164' right of centerline, up to 374' MSL.

Tree 591' from DER, 656' right of centerline, 379' MSL.

Trees beginning 655' from DER, 670' right of centerline, up to 394' MSL.

Tree 1033' from DER, 731' right of centerline, 408' MSL.

Tree 1043' from DER, 759' left of centerline, 398' MSL.

Trees beginning 1060' from DER, 384' right of centerline, up to 91' AGL/411' MSL.

Trees beginning 1073' from DER, 226' left of centerline, up to 87' AGL/402' MSL.

Tree, transmission line, pole beginning 1383' from DER, 95' right of centerline, up to 95' AGL/419' MSL.

Trees beginning 1625' from DER, 212' left of centerline, up to 76' AGL/410' MSL.

CONT

# TAKEOFF MINIMUMS, (OBSTACLE) DEPARTURE PROCEDURES, AND DIVERSE VECTOR AREA (RADAR VECTORS)

23334

# TAKEOFF MINIMUMS, (OBSTACLE) DEPARTURE PROCEDURES, AND DIVERSE VECTOR AREA (RADAR VECTORS)

23334

## HARRISBURG, PA (CON'T)

### HARRISBURG/CAPITAL CITY (CXY) (CON'T)

**Rwy 26 (CON'T)**, trees beginning 1710' from DER, 248' left of centerline, up to 413' MSL.  
 Trees beginning 1828' from DER, 147' left of centerline, up to 78' AGL/416' MSL.  
 Trees beginning 2115' from DER, 86' left of centerline, up to 78' AGL/442' MSL.  
 Tree, pole beginning 2497' from DER, 50' left of centerline, up to 447' MSL.  
 Trees beginning 2519' from DER, 189' right of centerline, up to 423' MSL.  
 Tree, transmission line beginning 2542' from DER, 5' right of centerline, up to 425' MSL.  
 Trees beginning 2645' from DER, 148' left of centerline, up to 457' MSL.  
 Trees beginning 2646' from DER, 52' right of centerline, up to 427' MSL.  
 Tree 2692' from DER, 221' right of centerline, 70' AGL/428' MSL.  
 Tree, transmission line beginning 2698' from DER, 255' right of centerline, up to 436' MSL.  
 Trees beginning 2861' from DER, 292' right of centerline, up to 438' MSL.  
 Tree, transmission line beginning 2902' from DER, 204' right of centerline, up to 446' MSL.  
 Trees beginning 3076' from DER, 240' right of centerline, up to 449' MSL.  
 Trees beginning 3120' from DER, 357' left of centerline, up to 89' AGL/458' MSL.  
 Tree, transmission line beginning 3162' from DER, 442' right of centerline, up to 451' MSL.  
 Tree, transmission line beginning 3171' from DER, 52' right of centerline, up to 458' MSL.  
 Trees beginning 3238' from DER, 467' left of centerline, up to 107' AGL/465' MSL.  
 Trees beginning 3427' from DER, 184' left of centerline, up to 103' AGL/466' MSL.  
 Trees beginning 3619' from DER, 98' left of centerline, up to 477' MSL.  
 Tree, general utility poles beginning 3834' from DER, 116' left of centerline, up to 478' MSL.  
 Trees beginning 3996' from DER, 423' right of centerline, up to 78' AGL/461' MSL.  
 Trees beginning 4004' from DER, 365' right of centerline, up to 81' AGL/466' MSL.  
 Tree, transmission line beginning 4027' from DER, 280' right of centerline, up to 87' AGL/470' MSL.  
 Tree, pole beginning 4495' from DER, 323' left of centerline, up to 493' MSL.  
 Trees beginning 4965' from DER, 340' left of centerline, up to 69' AGL/494' MSL.  
 Tree, pole, sign beginning 5136' from DER, 694' left of centerline, up to 67' AGL/503' MSL.  
 Tree, pole, sign, vehicle on traverse way beginning 5386' from DER, 558' left of centerline, up to 507' MSL.  
 Tree 5698' from DER, 1965' left of centerline, 520' MSL.  
 Trees beginning 5707' from DER, 108' left of centerline, up to 541' MSL.  
 Trees beginning 1 NM from DER, 581' left of centerline, up to 542' MSL.  
 Trees beginning 1 NM from DER, 1468' left of centerline, up to 545' MSL.  
 Tree 1 NM from DER, 2161' left of centerline, 56' AGL/578' MSL.  
 Trees beginning 1 NM from DER, 366' left of centerline, up to 581' MSL.  
 Tree 1 NM from DER, 34' right of centerline, 57' AGL/520' MSL.  
 Trees beginning 1 NM from DER, 22' left of centerline, up to 80' AGL/599' MSL.  
 Trees beginning 1.1 NM from DER, 2' right of centerline, up to 79' AGL/528' MSL.  
 Trees beginning 1.1 NM from DER, 1669' left of centerline, up to 610' MSL.  
 Trees beginning 1.1 NM from DER, 182' left of centerline, up to 87' AGL/639' MSL.  
 Trees beginning 1.2 NM from DER, 889' left of centerline, up to 74' AGL/656' MSL.  
 Tree, building, pole beginning 1.2 NM from DER, 931' left of centerline, up to 62' AGL/661' MSL.  
 Tree, building beginning 1.2 NM from DER, 567' left of centerline, up to 59' AGL/664' MSL.  
 Trees beginning 1.3 NM from DER, 384' left of centerline, up to 669' MSL.  
 Trees beginning 1.3 NM from DER, 505' left of centerline, up to 101' AGL/682' MSL.  
 Tree, building beginning 1.3 NM from DER, 794' left of centerline, up to 84' AGL/686' MSL.  
 Trees beginning 1.3 NM from DER, 552' left of centerline, up to 690' MSL.  
 Tree, pole beginning 1.4 NM from DER, 338' left of centerline, up to 97' AGL/692' MSL.  
 Tree 1.5 NM from DER, 2053' left of centerline, 696' MSL.  
 Trees beginning 1.5 NM from DER, 1571' left of centerline, up to 76' AGL/699' MSL.  
 Trees beginning 1.5 NM from DER, 1138' left of centerline, up to 79' AGL/704' MSL.  
 Tree, transmission line, vegetation, tower, antenna beginning 1.6 NM from DER, 416' left of centerline, up to 711' MSL.  
 Tree 1.5 NM from DER, 2053' left of centerline, 696' MSL.  
 Trees beginning 1.5 NM from DER, 1571' left of centerline, up to 76' AGL/699' MSL.  
 Trees beginning 1.5 NM from DER, 1138' left of centerline, up to 79' AGL/704' MSL.  
 Tree, transmission line, vegetation, tower, antenna beginning 1.6 NM from DER, 416' left of centerline, up to 711' MSL.  
 Tree 1.5 NM from DER, 2053' left of centerline, 696' MSL.  
 Trees beginning 1.5 NM from DER, 1571' left of centerline, up to 76' AGL/699' MSL.  
 Trees beginning 1.5 NM from DER, 1138' left of centerline, up to 79' AGL/704' MSL.  
 Tree, transmission line, vegetation, tower, antenna beginning 1.6 NM from DER, 416' left of centerline, up to 711' MSL.

## HARRISBURG INTL (MDT)

### TAKEOFF MINIMUMS AND (OBSTACLE) DEPARTURE PROCEDURES AMDT 8A 15SEP16 (16259) (FAA)

#### TAKEOFF MINIMUMS:

**Rwy 13**, 300-2¼ or std. w/min. climb of 260' per NM to 700.

#### DEPARTURE PROCEDURE:

**Rwy 13**, climb heading 128° to 1700 before proceeding on course.

**Rwy 31**, climb heading 308° to 1900 before proceeding on course.

#### TAKEOFF OBSTACLE NOTES:

**Rwy 13**, grd 1' from DER, 356' left of centerline, 310' MSL.

Secondary rd, fence, vertical structure, bush, beginning 25' from DER, 474' left of centerline, up to 325' MSL.

Tree 1500' from DER, 811' left of centerline, 74' AGL/368' MSL.

Trees beginning 1571' from DER, 279' left of centerline, up to 80' AGL/370' MSL.

CON'T

# TAKEOFF MINIMUMS, (OBSTACLE) DEPARTURE PROCEDURES, AND DIVERSE VECTOR AREA (RADAR VECTORS)

23334

NE-4



# TAKEOFF MINIMUMS, (OBSTACLE) DEPARTURE PROCEDURES, AND DIVERSE VECTOR AREA (RADAR VECTORS)

23334

## HARRISBURG, PA (CON'T)

### HARRISBURG INTL (MDT)

**Rwy 13 (CON'T)**, trees beginning 1666' from DER, 388' left of centerline, up to 85' AGL/375' MSL.

Tree 1796' from DER, 536' left of centerline, 79' AGL/380' MSL.

Trees beginning 1846' from DER, 394' left of centerline, up to 111' AGL/399' MSL.

Tree 3164' from DER, 1301' right of centerline, 118' AGL/399' MSL.

Trees beginning 1.3 NM from DER, 135' left of centerline, up to 100' AGL/523' MSL.

Trees beginning 1.3 NM from DER, 436' left of centerline, up to 529' MSL.

Tree 1.3 NM from DER, 335' right of centerline, 93' AGL/518' MSL.

Trees beginning 1.3 NM from DER, 333' right of centerline, up to 519' MSL.

Tree, bush, beginning 1.3 NM from DER, 6' left of centerline, up to 76' AGL/548' MSL.

Bush beginning 1.3 NM from DER, 15' right of centerline, up to 525' MSL.

Tree, bush, beginning 1.3 NM from DER, 360' left of centerline, up to 78' AGL/551' MSL.

Trees beginning 1.3 NM from DER, 593' left of centerline, up to 59' AGL/559' MSL.

Pole, bush, beginning 1.3 NM from DER, 154' right of centerline, up to 11' AGL/531' MSL.

Trees beginning 1.3 NM from DER, 764' left of centerline, up to 560' MSL.

Trees beginning 1.3 NM from DER, 56' left of centerline, up to 562' MSL.

Pole, tree, beginning 1.3 NM from DER, 156' right of centerline, up to 12' AGL/533' MSL.

Trees beginning 1.4 NM from DER, 114' right of centerline, up to 551' MSL.

Trees beginning 1.4 NM from DER, 37' left of centerline, up to 563' MSL.

Trees beginning 1.4 NM from DER, 26' left of centerline, up to 567' MSL.

Trees beginning 1.4 NM from DER, 125' right of centerline, up to 562' MSL.

Tree, bush, secondary rd, beginning 1.4 NM from DER, 195' left of centerline, up to 571' MSL.

Trees beginning 1.4 NM from DER, 247' right of centerline, up to 54' AGL/577' MSL.

Trees beginning 1.5 NM from DER, 198' left of centerline, up to 579' MSL.

Trees beginning 1.5 NM from DER, 23' left of centerline, up to 65' AGL/596' MSL.

Tree, bldg, beginning 1.5 NM from DER, 4' right of centerline, up to 585' MSL.

Tree, trmsn twr, beginning 1.5 NM from DER, 22' left of centerline, up to 603' MSL.

Tree, pole, gen util, beginning 1.5 NM from DER, 8' right of centerline, up to 72' AGL/594' MSL.

T-1 twr 1.8 NM from DER, 3169' left of centerline, 148' AGL/598' MSL.

**Rwy 31**, tree 131' from DER, 356' left of centerline, 15' AGL/314' MSL.

NAVAID 300' from DER, on centerline, 9' AGL/319' MSL.

Bldg 434' from DER, 259' right of centerline, 10' AGL/321' MSL.

Bldg 435' from DER, 247' right of centerline, 15' AGL/325' MSL.

Power transmission line 1194' from DER, 740' right of centerline, 59' AGL/367' MSL.

Trmsn twr 1206' from DER, 740' right of centerline, 60' AGL/368' MSL.

Trmsn twr, tree, beginning 1492' from DER, 732' right of centerline, up to 62' AGL/370' MSL.

Trmsn twr, pole, power transmission line, tree, beginning 1779' from DER, 733' right of centerline, up to 65' AGL/373' MSL.

Tree 2721' from DER, 812' right of centerline, 71' AGL/380' MSL.

Tree 2821' from DER, 1215' right of centerline, 83' AGL/385' MSL.

## HAZLETON, PA

### HAZLETON RGNL (HZL)

#### TAKEOFF MINIMUMS AND (OBSTACLE) DEPARTURE PROCEDURES

AMDT 3 25APR19 (19115) (FAA)

#### TAKEOFF MINIMUMS:

**Rwy 10**, std. w/min. climb gradient of 378' per NM to 2300, or 1000-3 for VCOA.

**Rwy 28**, 200-1% or std. w/min. climb gradient of 329' per NM to 1900.

#### DEPARTURE PROCEDURE:

**Rwy 10**, climb on heading 104° to 2300 before proceeding on course.

#### VCOA:

**Rwy 10**, obtain ATC approval for VCOA when requesting IFR clearance. Climb in visual conditions to cross Hazleton Rgnl airport at or above 2500 before proceeding on course.

#### TAKEOFF OBSTACLE NOTES:

**Rwy 10**, tree 1' from DER, 435' left of centerline, 1606' MSL.

Tree 2' from DER, 176' right of centerline, 15' AGL/1601' MSL.

Tree, pole beginning 27' from DER, 0' of centerline, up to 1613' MSL.

Tree 58' from DER, 438' left of centerline, 1655' MSL.

Trees beginning 92' from DER, 386' left of centerline, up to 74' AGL/1670' MSL.

Tree 263' from DER, 520' left of centerline, 79' AGL/1675' MSL.

Tree, pole, vehicles on traverse way, fence beginning 271' from DER, 0' left of centerline, up to 84' AGL/1680' MSL.

Tree 292' from DER, 527' right of centerline, 1636' MSL.

Trees beginning 394' from DER, 467' right of centerline, up to 1644' MSL.

Trees beginning 554' from DER, 414' right of centerline, up to 1649' MSL.

Tree, pole beginning 667' from DER, 0' of centerline, up to 1654' MSL.

Tree, building beginning 1004' from DER, 41' left of centerline, up to 1681' MSL.

Tree, building, terrain beginning 1199' from DER, 92' left of centerline, up to 1686' MSL.

Trees beginning 1383' from DER, 137' left of centerline, up to 1687' MSL.

Trees beginning 1421' from DER, 502' left of centerline, up to 1697' MSL.

Trees beginning 1513' from DER, 133' left of centerline, up to 1704' MSL.

Trees beginning 1603' from DER, 1' left of centerline, up to 1705' MSL.

Trees beginning 2397' from DER, 37' right of centerline, up to 83' AGL/1657' MSL.

CON'T

# TAKEOFF MINIMUMS, (OBSTACLE) DEPARTURE PROCEDURES, AND DIVERSE VECTOR AREA (RADAR VECTORS)

23334

NE-4

# TAKEOFF MINIMUMS, (OBSTACLE) DEPARTURE PROCEDURES, AND DIVERSE VECTOR AREA (RADAR VECTORS)

23334

## HAZLETON, PA (CON'T)

### HAZLETON RGNL (HZN) (CON'T)

**Rwy 10 (CON'T)**, trees beginning 2436' from DER, 28' right of centerline, up to 1661' MSL.  
 Trees beginning 2469' from DER, 338' right of centerline, up to 83' AGL/1665' MSL.  
 Trees beginning 2485' from DER, 139' right of centerline, up to 91' AGL/1671' MSL.  
 Trees beginning 2485' from DER, 21' right of centerline, up to 90' AGL/1672' MSL.  
 Trees beginning 2512' from DER, 8' right of centerline, up to 95' AGL/1676' MSL.  
 Trees beginning 2582' from DER, 11' right of centerline, up to 88' AGL/1683' MSL.  
 Tree 2795' from DER, 485' right of centerline, 1685' MSL.  
 Trees beginning 2815' from DER, 4' right of centerline, up to 1687' MSL.  
 Tree 2915' from DER, 189' right of centerline, 81' AGL/1688' MSL.  
 Trees beginning 2924' from DER, 61' right of centerline, up to 85' AGL/1692' MSL.  
 Trees beginning 2987' from DER, 7' right of centerline, up to 84' AGL/1694' MSL.  
 Trees beginning 3043' from DER, 21' right of centerline, up to 84' AGL/1695' MSL.  
 Trees beginning 3053' from DER, 14' right of centerline, up to 84' AGL/1698' MSL.  
 Trees beginning 3168' from DER, 157' left of centerline, up to 1708' MSL.  
 Trees beginning 3175' from DER, 109' left of centerline, up to 1712' MSL.  
 Trees beginning 3247' from DER, 149' left of centerline, up to 1713' MSL.  
 Trees beginning 3271' from DER, 127' left of centerline, up to 1718' MSL.  
 Tree, building beginning 3396' from DER, 50' left of centerline, up to 1727' MSL.  
 Trees beginning 3431' from DER, 15' right of centerline, up to 69' AGL/1699' MSL.  
 Trees beginning 3467' from DER, 102' right of centerline, up to 70' AGL/1701' MSL.  
 Trees beginning 3543' from DER, 70' right of centerline, up to 70' AGL/1704' MSL.  
 Trees beginning 3563' from DER, 19' right of centerline, up to 77' AGL/1710' MSL.  
 Tree, building, vehicles on traverse way beginning 3701' from DER, 70' left of centerline, up to 1743' MSL.  
 Tree, building, vegetation beginning 3869' from DER, 4' left of centerline, up to 1744' MSL.  
 Trees beginning 3903' from DER, 9' right of centerline, up to 77' AGL/1711' MSL.  
 Trees beginning 4607' from DER, 55' right of centerline, up to 68' AGL/1712' MSL.  
 Tree, building beginning 4920' from DER, 216' left of centerline, up to 1746' MSL.  
**Rwy 28**, tree 2' from DER, 217' left of centerline, 1597' MSL.  
 Vegetation 7' from DER, 210' right of centerline, 1596' MSL.  
 Trees beginning 83' from DER, 371' right of centerline, up to 71' AGL/1618' MSL.  
 Trees beginning 150' from DER, 453' right of centerline, up to 1629' MSL.  
 Tree 160' from DER, 359' left of centerline, 1600' MSL.  
 Tree 227' from DER, 281' left of centerline, 1604' MSL.  
 Trees beginning 346' from DER, 376' right of centerline, up to 1639' MSL.  
 Tree 594' from DER, 607' left of centerline, 1614' MSL.  
 Tree 658' from DER, 383' left of centerline, 1616' MSL.  
 Tree 783' from DER, 613' left of centerline, 1619' MSL.  
 Tree 1568' from DER, 897' right of centerline, 1659' MSL.  
 Tree 1716' from DER, 691' right of centerline, 1662' MSL.  
 Trees beginning 1725' from DER, 898' right of centerline, up to 1666' MSL.  
 Tree 1748' from DER, 742' right of centerline, 1674' MSL.  
 Trees beginning 1807' from DER, 655' right of centerline, up to 1677' MSL.  
 Tree 1817' from DER, 535' left of centerline, 1643' MSL.  
 Tree, pole beginning 1839' from DER, 558' left of centerline, up to 1654' MSL.  
 pole 2049' from DER, 579' left of centerline, 39' AGL/1657' MSL.  
 Pole 2146' from DER, 952' left of centerline, up to 42' AGL/1658' MSL.  
 Trees beginning 2453' from DER, 1064' right of centerline, up to 1678' MSL.  
 Tree, sign, pole, vegetation beginning 2556' from DER, 38' right of centerline, up to 1681' MSL.  
 Pole 2599' from DER, 313' left of centerline, 43' AGL/1663' MSL.  
 Tree, pole beginning 2717' from DER, 364' left of centerline, up to 1670' MSL.  
 Tree, pole beginning 2832' from DER, 311' left of centerline, up to 1674' MSL.  
 Tree, pole, sign beginning 2892' from DER, 5' right of centerline, up to 40' AGL/1685' MSL.  
 Tree, pole, sign beginning 2895' from DER, 44' left of centerline, up to 1682' MSL.  
 Tree 3017' from DER, 233' right of centerline, 36' AGL/1686' MSL.  
 Tree, pole beginning 3025' from DER, 146' right of centerline, up to 41' AGL/1692' MSL.  
 Trees beginning 3175' from DER, 116' right of centerline, up to 1693' MSL.  
 Tree 3208' from DER, 616' left of centerline, 1684' MSL.  
 Tree, pole beginning 3285' from DER, 138' left of centerline, up to 1694' MSL.  
 Tree, pole beginning 3302' from DER, 156' right of centerline, up to 1704' MSL.  
 Tree, pole beginning 3453' from DER, 51' right of centerline, up to 1707' MSL.  
 Trees beginning 3484' from DER, 183' left of centerline, up to 43' AGL/1696' MSL.  
 Tree, pole beginning 3520' from DER, 207' left of centerline, up to 47' AGL/1703' MSL.  
 Tree, pole beginning 3560' from DER, 83' right of centerline, up to 37' AGL/1708' MSL.  
 Tree 3646' from DER, 1339' right of centerline, 1709' MSL.  
 Tree, pole beginning 3651' from DER, 220' right of centerline, up to 1712' MSL.  
 Tree, building beginning 3692' from DER, 48' right of centerline, up to 1718' MSL.  
 Tree, pole beginning 3761' from DER, 105' right of centerline, up to 1721' MSL.  
 Tree 3815' from DER, 37' left of centerline, 49' AGL/1716' MSL.  
 Trees beginning 3826' from DER, 16' left of centerline, up to 53' AGL/1724' MSL.  
 Tree 3862' from DER, 73' left of centerline, 59' AGL/1725' MSL.  
 Trees beginning 3865' from DER, 2' left of centerline, up to 49' AGL/1727' MSL.  
 Tree, pole beginning 3873' from DER, 3' right of centerline, up to 1734' MSL.  
 Tree, pole beginning 3886' from DER, 0' left of centerline, up to 53' AGL/1730' MSL.  
**CON'T**

22 FEB 2024 to 21 MAR 2024

22 FEB 2024 to 21 MAR 2024

# TAKEOFF MINIMUMS, (OBSTACLE) DEPARTURE PROCEDURES, AND DIVERSE VECTOR AREA (RADAR VECTORS)

23334

NE-4

# TAKEOFF MINIMUMS, (OBSTACLE) DEPARTURE PROCEDURES, AND DIVERSE VECTOR AREA (RADAR VECTORS)

23334

## HAZLETON, PA (CON'T)

### HAZLETON RGNL (HZN) (CON'T)

**Rwy 28 (CON'T)**, tree, pole beginning 3958' from DER, 63' right of centerline, up to 1740' MSL.  
 Tree, pole beginning 4005' from DER, 55' right of centerline, up to 45' AGL/1741' MSL.  
 Trees beginning 4049' from DER, 192' right of centerline, up to 49' AGL/1743' MSL.  
 Tree, pole beginning 4063' from DER, 29' right of centerline, up to 48' AGL/1745' MSL.  
 Tree, pole, building beginning 4097' from DER, 8' right of centerline, up to 1747' MSL.  
 Tree, pole, building, vehicles on traverse way, fence beginning 4327' from DER, 0' right of centerline, up to 57' AGL/1773' MSL.  
 Trees beginning 4337' from DER, 35' left of centerline, up to 53' AGL/1732' MSL.  
 Trees beginning 4361' from DER, 123' left of centerline, up to 52' AGL/1733' MSL.  
 Trees beginning 4367' from DER, 53' left of centerline, up to 54' AGL/1735' MSL.  
 Tree, tank beginning 4382' from DER, 4' left of centerline, up to 66' AGL/1746' MSL.  
 Tree, building beginning 4591' from DER, 9' left of centerline, up to 60' AGL/1747' MSL.

## HONESDALE, PA

### CHERRY RIDGE (N30)

#### TAKEOFF MINIMUMS AND (OBSTACLE) DEPARTURE PROCEDURES

AMDT 4 03JUN10 (10154) (FAA)

##### TAKEOFF MINIMUMS:

**Rwy 18**, 500-2½ or std. w/ min. climb of 210' per NM to 1800, or alternatively, with standard TAKEOFF minimums and a normal 200'/NM climb gradient, TAKEOFF must occur no later than 1400' prior to DER.

**Rwy 36**, 500-2¼ or std. w/ min. climb of 642' per NM to 1900.

##### DEPARTURE PROCEDURE:

**Rwy 18**, climb heading 180° to 1800 before turning right.

##### TAKEOFF OBSTACLE NOTES:

**Rwy 18**, tree 3' from DER, 358' right of centerline, 100' AGL/1419' MSL.

**Rwy 36**, trees beginning 1' from DER, 500' left of centerline, up to 100' AGL/1439' MSL.

## HUNTINGTON, WV

### TRI-STATE/MILTON J FERGUSON FLD (HTS)

#### TAKEOFF MINIMUMS AND (OBSTACLE) DEPARTURE PROCEDURES

AMDT 1 13JAN11 (21112) (FAA)

##### DEPARTURE PROCEDURE:

**Rwy 30**, climb heading 313° to 1800 before turning left.

##### TAKEOFF OBSTACLE NOTES:

**Rwy 12**, trees beginning 146' from DER, 220' right of centerline, up to 106' AGL/885' MSL.

Trees beginning 304' from DER, 230' left of centerline, up to 97' AGL/856' MSL.

**Rwy 30**, trees beginning 254' from DER, 127' left of centerline, up to 89' AGL/928' MSL.

Trees beginning 76' from DER, 137' right of centerline, up to 105' AGL/944' MSL.

## INDIANA, PA

### INDIANA COUNTY/JIMMY STEWART FLD (IDI)

#### TAKEOFF MINIMUMS AND (OBSTACLE) DEPARTURE PROCEDURES

ORIG 15SEP16 (21168) (FAA)

##### TAKEOFF MINIMUMS:

**Rwy 11**, 300-1¼ w/ min. climb of 206' per NM to 2300 or std. w/min. climb of 418' per NM to 2300 or 1300-3 for climb in visual conditions.

**Rwy 29**, 300-2 w/min. climb of 251' per NM to 1800 or std. w/min. climb of 289' per NM to 1800.

##### DEPARTURE PROCEDURE:

**Rwy 11**, climb heading 106° to 2300 before proceeding on course.

**Rwy 29**, climb heading 286° to 1800 before proceeding east.

##### VCOA:

**Rwy 11**, obtain ATC approval for climb in visual conditions when requesting IFR clearance. Climb in visual conditions to cross Indiana County/Jimmy Stewart Fld at or above 2600 before proceeding on course.

##### TAKEOFF OBSTACLE NOTES:

**Rwy 11**, tree 12' from DER, 394' right of centerline, 22' AGL/1435' MSL.

Ground 21' from DER, 243' left of centerline, 1421' MSL.

Tree, ground beginning 44' from DER, 458' right of centerline, up to 45' AGL/1449' MSL.

Ground beginning 761' from DER, 578' right of centerline, up to 1464' MSL.

Ground beginning 881' from DER, 518' right of centerline, up to 1473' MSL.

Trees beginning 1163' from DER, 492' right of centerline, up to 50' AGL/1477' MSL.

Tree 1560' from DER, 871' right of centerline, 94' AGL/1493' MSL.

Tree 2774' from DER, 1102' right of centerline, 48' AGL/1494' MSL.

Tree 2790' from DER, 953' right of centerline, 63' AGL/1497' MSL.

Trees beginning 2967' from DER, 787' right of centerline, up to 45' AGL/1540' MSL.

Tree 3102' from DER, 874' right of centerline, 57' AGL/1549' MSL.

Tree 3108' from DER, 1114' right of centerline, 49' AGL/1553' MSL.

Trees beginning 3176' from DER, 707' right of centerline, up to 58' AGL/1561' MSL.

Tree 3222' from DER, 1029' left of centerline, 68' AGL/1503' MSL.

Tree 3270' from DER, 1073' left of centerline, 78' AGL/1515' MSL.

Trees beginning 3412' from DER, 625' right of centerline, up to 49' AGL/1570' MSL.

CON'T

# TAKEOFF MINIMUMS, (OBSTACLE) DEPARTURE PROCEDURES, AND DIVERSE VECTOR AREA (RADAR VECTORS)

23334

NE-4

# TAKEOFF MINIMUMS, (OBSTACLE) DEPARTURE PROCEDURES, AND DIVERSE VECTOR AREA (RADAR VECTORS)

23334

## INDIANA, PA (CON'T)

### INDIANA COUNTY/JIMMY STEWART FLD (IDI) (CON'T)

**Rwy 11 (CON'T)**, trees beginning 3463' from DER, 971' left of centerline, up to 69' AGL/1518' MSL.

Trees beginning 3616' from DER, 789' right of centerline, up to 55' AGL/1588' MSL.

Trees beginning 3694' from DER, 987' right of centerline, up to 53' AGL/1596' MSL.

Trees beginning 3816' from DER, 962' right of centerline, up to 67' AGL/1614' MSL.

Tree 3881' from DER, 1185' left of centerline, 78' AGL/1519' MSL.

Trees beginning 3936' from DER, 976' right of centerline, up to 65' AGL/1629' MSL.

Trees beginning 4984' from DER, 1681' left of centerline, up to 63' AGL/1549' MSL.

Tree 5066' from DER, 1410' left of centerline, 76' AGL/1557' MSL.

Tree 5077' from DER, 1589' left of centerline, 65' AGL/1567' MSL.

Trees beginning 5112' from DER, 1305' left of centerline, up to 68' AGL/1584' MSL.

Trees beginning 5351' from DER, 1391' left of centerline, up to 61' AGL/1590' MSL.

Tree 5421' from DER, 1848' left of centerline, 52' AGL/1585' MSL.

**Rwy 29**, vehicle on road 588' from DER, 617' right of centerline, 1389' MSL.

Vehicle on road beginning 594' from DER, 626' right of centerline, up to 1390' MSL.

Tree 753' from DER, 598' right of centerline, 26' AGL/1402' MSL.

Tree, vehicle on road beginning 758' from DER, 526' right of centerline, up to 24' AGL/1404' MSL.

Trees beginning 926' from DER, 479' right of centerline, up to 26' AGL/1421' MSL.

Trees beginning 1135' from DER, 478' right of centerline, up to 49' AGL/1455' MSL.

Trees beginning 1251' from DER, 391' right of centerline, up to 65' AGL/1482' MSL.

Tree 1289' from DER, 546' left of centerline, 61' AGL/1403' MSL.

Tree 1292' from DER, 571' left of centerline, 67' AGL/1404' MSL.

Tree 4156' from DER, 788' left of centerline, 64' AGL/1491' MSL.

Trees beginning 4158' from DER, 446' left of centerline, up to 59' AGL/1493' MSL.

Trees beginning 4459' from DER, 410' left of centerline, up to 60' AGL/1494' MSL.

Trees beginning 4567' from DER, 224' left of centerline, up to 59' AGL/1496' MSL.

Tree 4583' from DER, 336' right of centerline, 70' AGL/1483' MSL.

Tree 4646' from DER, 439' right of centerline, 61' AGL/1501' MSL.

Trees beginning 4670' from DER, 154' right of centerline, up to 60' AGL/1503' MSL.

Trees beginning 4762' from DER, 92' right of centerline, up to 58' AGL/1505' MSL.

Tree 4926' from DER, 868' right of centerline, 64' AGL/1515' MSL.

Tree 4930' from DER, 635' right of centerline, 58' AGL/1519' MSL.

Trees beginning 4941' from DER, 7' right of centerline, up to 72' AGL/1533' MSL.

Trees beginning 5176' from DER, 351' right of centerline, up to 77' AGL/1543' MSL.

Tree 5200' from DER, 173' left of centerline, 70' AGL/1499' MSL.

Tree 5222' from DER, 617' right of centerline, 76' AGL/1544' MSL.

Trees beginning 5277' from DER, 32' right of centerline, up to 90' AGL/1558' MSL.

Trees beginning 5529' from DER, 293' right of centerline, up to 92' AGL/1565' MSL.

Tree 5754' from DER, 632' left of centerline, 88' AGL/1528' MSL.

Trees beginning 5989' from DER, 668' left of centerline, up to 83' AGL/1551' MSL.

Trees beginning 1 NM from DER, 115' left of centerline, up to 90' AGL/1577' MSL.

Trees beginning 1 NM from DER, 64' left of centerline, up to 77' AGL/1578' MSL.

Trees beginning 1 NM from DER, 45' left of centerline, up to 90' AGL/1584' MSL.

Trees beginning 1 NM from DER, 5' left of centerline, up to 89' AGL/1590' MSL.

Trees beginning 1.1 NM from DER, 28' right of centerline, up to 83' AGL/1572' MSL.

Trees beginning 1.1 NM from DER, 422' right of centerline, up to 83' AGL/1574' MSL.

Trees beginning 1.1 NM from DER, 183' right of centerline, up to 89' AGL/1578' MSL.

Trees beginning 1.1 NM from DER, 59' right of centerline, up to 89' AGL/1582' MSL.

Tree 1.4 NM from DER, 1982' right of centerline, 58' AGL/1590' MSL.

Trees beginning 1.4 NM from DER, 1783' right of centerline, up to 61' AGL/1605' MSL.

Tree 1.5 NM from DER, 1252' right of centerline, 59' AGL/1612' MSL.

Tank, tree, water tower, communication tower, beginning 1.5 NM from DER, 1250' right of centerline, up to 109' AGL/1668' MSL.

Tower 1.6 NM from DER, 1292' right of centerline, 121' AGL/1676' MSL.

Communication tower, tower, beginning 1.6 NM from DER, 1076' right of centerline, up to 116' AGL/1677' MSL.

Communication tower 1.6 NM from DER, 1135' right of centerline, 115' AGL/1676' MSL.

## JOHNSTOWN, PA

### JOHN MURTHA JOHNSTOWN/CAMBRIA COUNTY (JST)

#### TAKEOFF MINIMUMS AND (OBSTACLE) DEPARTURE PROCEDURES

AMDT 4A 11OCT18 (22027) (FAA)

##### TAKEOFF OBSTACLE NOTES:

**Rwy 5**, sign 62' from DER, 256' right of centerline, 3' AGL/2282' MSL.

Building 97' from DER, 480' left of centerline, 28' AGL/2299' MSL.

Building 514' from DER, 516' left of centerline, 46' AGL/2311' MSL.

Tree 687' from DER, 647' left of centerline, 2326' MSL.

Tree 778' from DER, 377' right of centerline, 2300' MSL.

Trees beginning 903' from DER, 300' left of centerline, up to 2341' MSL.

**Rwy 23**, trees beginning 2' from DER, 426' right of centerline, up to 2300' MSL.

Tree 20' from DER, 489' left of centerline, 2308' MSL.

Trees beginning 1115' from DER, 360' left of centerline, up to 2345' MSL.

**Rwy 33**, terrain 7' from DER, 15' left of centerline, 2271' MSL.

Fence 179' from DER, 467' right of centerline, 8' AGL/2275' MSL.

CON'T

# TAKEOFF MINIMUMS, (OBSTACLE) DEPARTURE PROCEDURES, AND DIVERSE VECTOR AREA (RADAR VECTORS)

23334

NE-4

# TAKEOFF MINIMUMS, (OBSTACLE) DEPARTURE PROCEDURES, AND DIVERSE VECTOR AREA (RADAR VECTORS)

23334

## JOHNSTOWN, PA (CON'T)

### JOHN MURTHA JOHNSTOWN/CAMBRIA COUNTY (JST) (CON'T)

**Rwy 33 (CON'T)**, tree 359' from DER, 463' right of centerline, 2281' MSL.

Trees beginning 639' from DER, 318' right of centerline, up to 2309' MSL.

## LANCASTER, PA

### LANCASTER (LNS)

#### TAKEOFF MINIMUMS AND (OBSTACLE) DEPARTURE PROCEDURES

AMDT 1 17DEC09 (09351) (FAA)

##### TAKEOFF MINIMUMS:

**Rwy 8**, 300-1½ or std. w/ min. climb of 301' per NM to 700.

**Rwy 31**, 300-1½ or std. w/ min. climb of 210' per NM to 700, or alternatively with standard takeoff minimums and a normal 200'/NM climb gradient, takeoff must occur no later than 1300' prior to DER.

##### DEPARTURE PROCEDURE:

**Rwy 8**, climb heading 077° to 800 before turning left.

##### TAKEOFF OBSTACLE NOTES:

**Rwy 8**, silo 590' from DER, 637' right of centerline, 88' AGL/427' MSL.

Trees beginning 825' from DER, 41' right of centerline, up to 100' AGL/425' MSL.

Trees beginning 1336' from DER, 281' left of centerline, up to 100' AGL/579' MSL.

**Rwy 13**, trees beginning 2322' from DER, 902' right of centerline, up to 100' AGL/499' MSL.

Trees beginning 615' from DER, 328' left of centerline, up to 43' AGL/442' MSL.

**Rwy 26**, vehicles on road beginning 269' from DER, 494' right of centerline, up to 15' AGL/403' MSL.

Tree 1257' from DER, 797' right of centerline, 59' AGL/439' MSL.

Trees beginning 1927' from DER, 915' left of centerline, up to 100' AGL/489' MSL.

**Rwy 31**, trees beginning 1334' from DER, 350' right of centerline, up to 100' AGL/571' MSL.

Pole 402' from DER, 221' left of centerline, 24' AGL/404' MSL.

Building 527' from DER, 229' left of centerline, 29' AGL/409' MSL.

Trees beginning 956' from DER, 88' left of centerline, up to 100' AGL/489' MSL.

## LATROBE, PA

### ARNOLD PALMER RGNL (LBE)

#### TAKEOFF MINIMUMS AND (OBSTACLE) DEPARTURE PROCEDURES

AMDT 7 29MAR18 (18088) (FAA)

##### TAKEOFF MINIMUMS:

**Rwy 6**, std. w/ min. climb of 220' per NM to 3300 or 1700-3 for VCOA.

##### DEPARTURE PROCEDURE:

**Rwy 6**, climb heading 041° to 3300 before proceeding on course.

**Rwy 24**, climb heading 236° to 2300 before proceeding on course.

##### VCOA:

**Rwy 6**, obtain ATC approval for VCOA when requesting IFR clearance. Climb in visual conditions to cross Arnold Palmer RGNL airport at or above 2700 before proceeding on course.

##### TAKEOFF OBSTACLE NOTES:

**Rwy 6**, building 143' from DER, 412' left of centerline, 14' AGL/1143' MSL.

Poles beginning 1184' from DER, 750' right of centerline, up to 40' AGL/1300' MSL.

Tree 2046' from DER, 234' left of centerline, 1187' MSL.

Tree 3077' from DER, 264' right of centerline, 57' AGL/1217' MSL.

Tree 4788' from DER, 951' left of centerline, 82' AGL/1260' MSL.

**Rwy 24**, pole 511' from DER, 578' left of centerline, 40' AGL/1239' MSL.

Trees and pole beginning 634' from DER, 389' left of centerline, up to 1256' MSL.

Trees beginning 1421' from DER, 774' right of centerline, up to 1257' MSL.

Trees beginning 1824' from DER, 784' right of centerline, up to 1275' MSL.

Trees beginning 2656' from DER, 1161' right of centerline, up to 93' AGL/1296' MSL.

Tree 3093' from DER, 1193' right of centerline, 62' AGL/1310' MSL.

Trees beginning 3106' from DER, 958' right of centerline, up to 53' AGL/1322' MSL.

Trees beginning 3352' from DER, 1020' right of centerline, up to 65' AGL/1348' MSL.

## LEBANON, PA

### KELLER BROTHERS (08N)

#### TAKEOFF MINIMUMS AND (OBSTACLE) DEPARTURE PROCEDURES

ORIG 31MAY12 (12152) (FAA)

##### TAKEOFF MINIMUMS:

**Rwy 7**, 500-3 w/ min. climb of 231' per NM to 1200 or 1500-2 ½ for climb in visual conditions.

**Rwy 25**, 800-3 w/ min. climb of 370' per NM to 1600 or 1500-2 ½ for climb in visual conditions.

##### DEPARTURE PROCEDURE:

**Rwy 7**, climb heading 068° to 2000 before turning right, or for climb in visual conditions cross Keller Brothers Airport at or above 1900, before proceeding on course.

**Rwy 25**, climb heading 248° to 2500 before proceeding on course, or for climb in visual conditions cross Keller Brothers Airport at or above 1900, before proceeding on course.

##### TAKEOFF OBSTACLE NOTES:

**Rwy 7**, trees and buildings beginning 223' from DER, 113' left of centerline, up to 100' AGL/719' MSL.

Trees and buildings beginning 1.6 NM from DER, 2422' right of centerline, up to 100' AGL/1499' MSL.

**Rwy 25**, trees and buildings beginning 47' from DER, 39' right of centerline, up to 100' AGL/659' MSL.

Trees and buildings beginning 355' from DER, 4' left of centerline, up to 100' AGL/1339' MSL.

# TAKEOFF MINIMUMS, (OBSTACLE) DEPARTURE PROCEDURES, AND DIVERSE VECTOR AREA (RADAR VECTORS)

23334

# TAKEOFF MINIMUMS, (OBSTACLE) DEPARTURE PROCEDURES, AND DIVERSE VECTOR AREA (RADAR VECTORS)

23334

## LEHIGHTON, PA

JAKE ARNER MEML (22N)

TAKEOFF MINIMUMS AND (OBSTACLE) DEPARTURE PROCEDURES

AMDT 1 05MAY11 (21280) (FAA)

TAKEOFF MINIMUMS:

**Rwy 8**, std. w/min. climb of 426' per NM to 1700 or 600-2¼ with min. climb of 269' per NM to 1700 or 2000-3 for climb in visual conditions.

**Rwy 26**, std. w/min. climb of 362' per NM to 1600 or 2000-3 for climb in visual conditions.

DEPARTURE PROCEDURE:

**Rwy 8**, climb heading 081° to 2400 before proceeding on course, or for climb in visual conditions cross Jake Arner Meml airport at or above 2500 before proceeding on course.

**Rwy 26**, climb heading 261° to 1900 before proceeding on course, or for climb in visual conditions cross Jake Arner Meml airport at or above 2500 before proceeding on course.

TAKEOFF OBSTACLE NOTES:

**Rwy 8**, trees beginning 1961' from DER, 42' left of centerline, up to 100' AGL/426' MSL.

Trees beginning 5388' from DER, 1817' right of centerline, up to 100' AGL/359' MSL.

Building 1.5 NM from DER, 1826' right of centerline, 31' AGL/876' MSL.

Tower 2.9 NM from DER, 4326' right of centerline, 207' AGL/967' MSL.

**Rwy 26**, trees beginning 3282' from DER, 10' left of centerline, up to 100' AGL/659' MSL.

Trees beginning 4511' from DER, 879' right of centerline, up to 100' AGL/699' MSL.

## LEWISBURG, WV

GREENBRIER VALLEY (LWB)

TAKEOFF MINIMUMS AND (OBSTACLE) DEPARTURE PROCEDURES

AMDT 4A 19JUL18 (18200) (FAA)

DEPARTURE PROCEDURE:

**Rwy 4**, climb heading 043° to 3800 before proceeding on course.

**Rwy 22**, climb heading 223° to 3300 before proceeding on course.

TAKEOFF OBSTACLE NOTES:

**Rwy 4**, tree 1617' from DER, 528' right of centerline, 84' AGL/2364' MSL.

**Rwy 22**, trees beginning 759' from DER 553' left of centerline, 60' AGL/2309' MSL.

Trees beginning 1996' from DER, 289' right of centerline, up to 104' AGL/2364' MSL.

## LOCK HAVEN, PA

WILLIAM T PIPER MEML (LHV)

TAKEOFF MINIMUMS AND (OBSTACLE) DEPARTURE PROCEDURES

AMDT 1 23NOV06 (21280) (FAA)

TAKEOFF MINIMUMS:

**Rwys 9L/R**, NA-Obstacles.

**Rwy 27L**, NA-ATC.

**Rwy 27R**, std. w/min. climb of 393' per NM to 2500 or 2300-3 for climb in visual conditions.

DEPARTURE PROCEDURE:

**Rwy 27R**, climb heading 273° to 2500 before proceeding on course or for climb in visual conditions cross William T Piper Meml airport at or above 2700 MSL before proceeding on course.

TAKEOFF OBSTACLE NOTES:

**Rwy 27R**, multiple terrain and trees beginning 1.4 NM from DER, 1194' right of centerline, up to 100' AGL/1119' MSL.

Tower 1.8 NM from DER, 349' right of centerline, 154' AGL/895' MSL.

## LOGAN, WV

LOGAN COUNTY (6L4)

TAKEOFF MINIMUMS AND (OBSTACLE) DEPARTURE PROCEDURES

AMDT 1 07MAR13 (13066) (FAA)

DEPARTURE PROCEDURE:

**Rwy 24**, climb heading 245° to 3000 before proceeding on course.

TAKEOFF OBSTACLE NOTES:

**Rwy 6**, trees beginning 46' from DER, 150' left of centerline, up to 49' AGL/ 1683' MSL.

Trees beginning 358' from DER, 273' right of centerline, up to 82' AGL/ 1691' MSL.

**Rwy 24**, trees 132' from DER, 193' right of centerline, up to 37' AGL/ 1682' MSL.

Fence 556' from DER, 145' right of centerline, 18' AGL/ 1673' MSL.

Vehicles on road beginning 2187' from DER, crossing left to right, 22' AGL/ 1735' MSL.

Trees beginning 2335' from DER, 71' right of centerline, up to 121' AGL/ 1775' MSL.

Tree 1408' from DER, 34' left of centerline, up to 134' AGL/ 1751' MSL.

Building 1954' from DER, 312' left of centerline, 10' AGL/ 1726' MSL.

# TAKEOFF MINIMUMS, (OBSTACLE) DEPARTURE PROCEDURES, AND DIVERSE VECTOR AREA (RADAR VECTORS)

23334

NE-4

# TAKEOFF MINIMUMS, (OBSTACLE) DEPARTURE PROCEDURES, AND DIVERSE VECTOR AREA (RADAR VECTORS)

23334

## MARTINSBURG, WV

EASTERN WV RGNL/SHEPHERD FLD (MRB)

TAKEOFF MINIMUMS AND (OBSTACLE) DEPARTURE PROCEDURES

AMD T 7 31MAR16 (22083) (FAA)

DEPARTURE PROCEDURE:

**Rwy 8**, climb heading 079° to 1200 before turning westbound.**Rwy 26**, climb heading 259° to 1000, then climbing left turn to 2500 direct MRB VORTAC before proceeding on course.

TAKEOFF OBSTACLE NOTES:

**Rwy 8**, tree 704' from DER, 278' right of centerline, 587' MSL.

Tree 827' from DER, 575' left of centerline, 592' MSL.

Trees beginning 879' from DER, 340' right of centerline, up to 593' MSL.

Trees beginning 984' from DER, 309' left of centerline, up to 594' MSL.

Tree 1322' from DER, 392' right of centerline, 599' MSL.

Trees beginning 1510' from DER, 553' right of centerline, up to 602' MSL.

Tree 1729' from DER, 503' right of centerline, 603' MSL.

**Rwy 26**, terrain 165' from DER, 468' right of centerline, up to 569' MSL.

## MEADVILLE, PA

PORT MEADVILLE (GKJ)

TAKEOFF MINIMUMS AND (OBSTACLE) DEPARTURE PROCEDURES

AMD T 4 23SEP10 (10266) (FAA)

DEPARTURE PROCEDURE:

**Rwy 7**, climb heading 069° to 2000 before proceeding on course.

TAKEOFF OBSTACLE NOTES:

**Rwy 7**, pole and trees beginning 30' from DER, 128' left of centerline, up to 86' AGL/1465' MSL.

Terrain and trees beginning 58' from DER, 174' right of centerline, up to 96' AGL/1455' MSL.

**Rwy 25**, trees beginning 33' from DER, 41' left of centerline, up to 90' AGL/1449' MSL.

Trees beginning 51' from DER, 17' right of centerline, up to 106' AGL/1455' MSL.

## MIFFLINTOWN, PA

MIFFLINTOWN (P34)

TAKEOFF MINIMUMS AND (OBSTACLE) DEPARTURE PROCEDURES

AMD T 1 23NOV06 (06327) (FAA)

TAKEOFF MINIMUMS:

**Rwy 8**, std. with a min. climb of 500' per NM to 4000 or 2100-3 for climb in visual conditions.**Rwy 26**, NA-obstacles.

DEPARTURE PROCEDURE:

**Rwy 8**, climb heading 090° to 4000 before proceeding on course or for climb in visual conditions: cross Mifflintown Airport at or above 2500 MSL before proceeding on course.

TAKEOFF OBSTACLE NOTES:

**Rwy 8**, multiple terrain and trees beginning 1332' from DER, 356' left of centerline, up to 200' AGL/839' MSL.

Trees 1.2 NM from DER, 2350' right of centerline, up to 100' AGL/759' MSL.

## MILTON, WV

ONA AIRPARK (12V)

TAKEOFF MINIMUMS AND (OBSTACLE) DEPARTURE PROCEDURES

AMD T 2 10APR08 (08101) (FAA)

TAKEOFF MINIMUMS:

**Rwys 7, 25**, 1900-3 climb in visual conditions.

DEPARTURE PROCEDURE:

**Rwys 7, 25**, Departure NA at night. For climb in visual conditions: cross Ona Airpark at or above 2300 MSL before proceeding on course. Do not exceed 180 KIAS until crossing Ona Airpark on course.

TAKEOFF OBSTACLE NOTES:

**Rwy 7**, trees beginning 730' from DER, 44' left of centerline, up to 100' AGL/1019' MSL.

Trees 4879' from DER, 597' right of centerline, up to 100' AGL/999' MSL.

Trees beginning 1.8 NM from DER, 2539' left of centerline, up to 100' AGL/1199' MSL.

Trees beginning 1.6 NM from DER, 556' right of centerline, up to 100' AGL/1199' MSL.

**Rwy 25**, trees beginning 94' from DER, 47' right of centerline, up to 100' AGL/719' MSL.

Towers and trees beginning 3016' from DER, 758' left of centerline, up to 125' AGL/822' MSL.

Trees beginning 2 NM from DER, 3193' left of centerline, up to 100' AGL/1079' MSL.

22 FEB 2024 to 21 MAR 2024

22 FEB 2024 to 21 MAR 2024

# TAKEOFF MINIMUMS, (OBSTACLE) DEPARTURE PROCEDURES, AND DIVERSE VECTOR AREA (RADAR VECTORS)

23334

NE-4

# TAKEOFF MINIMUMS, (OBSTACLE) DEPARTURE PROCEDURES, AND DIVERSE VECTOR AREA (RADAR VECTORS)

23334

## MONONGAHELA, PA

### ROSTRAVER (FWQ)

TAKEOFF MINIMUMS AND (OBSTACLE) DEPARTURE PROCEDURES

AMDT 1A 28JUL11 (11209) (FAA)

DEPARTURE PROCEDURE:

**Rwy 8**, climb heading 076° to 1800 before turning left.

TAKEOFF OBSTACLE NOTES:

**Rwy 8**, runway end identifier light and trees beginning 6' from DER, 18' left of centerline, up to 80' AGL/1339' MSL.

Runway end identifier light and trees beginning 7' from DER, 1' right of centerline, up to 81' AGL/1310' MSL.

**Rwy 26**, runway end identifier light, catenary, antenna, telephone pylons, poles, power lines and trees beginning 1' from DER, 46' left of centerline, up to 107' AGL/1354' MSL.

Runway end identifier light, light pole, and trees beginning 6' from DER, 77' right of centerline, up to 49' AGL/1268' MSL.

## MORGANTOWN, WV

### MORGANTOWN MUNI/WALTER L BILL HART FLD (MGW)

TAKEOFF MINIMUMS AND (OBSTACLE) DEPARTURE PROCEDURES

AMDT 6A 21MAY20 (22363) (FAA)

DEPARTURE PROCEDURE:

**Rwy 18**, climbing right turn on heading 225° to 2700 before proceeding on course.**Rwy 36**, climb on heading 360° to 2700 before proceeding on course.

TAKEOFF OBSTACLE NOTES:

**Rwy 18**, sign, vegetation beginning 25' from DER, 252' right of centerline, up to 4' AGL/1245' MSL.

Trees beginning 1447' from DER, 207' right of centerline, up to 1291' MSL.

Trees beginning 1561' from DER, 210' right of centerline, up to 1299' MSL.

Trees beginning 1838' from DER, 233' right of centerline, up to 1311' MSL.

Tree 2170' from DER, 1033' right of centerline, 1317' MSL.

Trees beginning 2370' from DER, 1063' right of centerline, up to 1324' MSL.

**Rwy 36**, sign 21' from DER, 287' left of centerline, 4' AGL/1238' MSL.

Trees beginning 65' from DER, 307' right of centerline, up to 1252' MSL.

Tree 412' from DER, 553' left of centerline, 1262' MSL.

## MOUNDSVILLE, WV

### MARSHALL COUNTY (MPG)

TAKEOFF MINIMUMS AND (OBSTACLE) DEPARTURE PROCEDURES

AMDT 2 24JUL14 (14205) (FAA)

TAKEOFF MINIMUMS:

**Rwy 6**, std. w/min. climb of 228' per NM to 1900 or 900-2½ for climb in visual conditions.**Rwy 24**, 300-2 or std. w/min. climb of 385' per NM to 1600.

DEPARTURE PROCEDURE:

**Rwy 6**, for climb in visual conditions cross Marshall County airport at or above 2000 before proceeding on course. When executing VCOA, notify ATC prior to departure.**Rwy 24**, climb heading 240° to 1700 before turning left.

TAKEOFF OBSTACLE NOTES:

**Rwy 6**, trees beginning 6' from DER, 65' left of centerline, up to 68' AGL/1207' MSL.

Trees beginning 46' from DER, 391' right of centerline, up to 122' AGL/1237' MSL.

Trees beginning 113' from DER, 85' right of centerline, up to 80' AGL/1219' MSL.

Trees beginning 156' from DER, 84' left of centerline, up to 48' AGL/1227' MSL.

Trees beginning 3967' from DER, 948' left of centerline, up to 100' AGL/1399' MSL.

Pole 4755' from DER, 65' left of centerline, 32' AGL/1316' MSL.

**Rwy 24**, trees beginning 10' from DER, 371' left of centerline, up to 65' AGL/1244' MSL.

Trees beginning 28' from DER, 74' right of centerline, up to 17' AGL/1216' MSL.

Trees beginning 116' from DER, 435' left of centerline, up to 98' AGL/1250' MSL.

Trees beginning 1349' from DER, 310' left of centerline, up to 112' AGL/1291' MSL.

Trees beginning 1644' from DER, 318' right of centerline, up to 78' AGL/1277' MSL.

AG equipment 2454' from DER, 729' right of centerline, 54' AGL/1316' MSL.

Poles and buildings beginning 2588' from DER, left and right of centerline, up to 55' AGL/1368' MSL.

Vehicle on road beginning 2881' from DER, 948' left of centerline, up to 15' AGL/1311' MSL.

Buildings and poles beginning 5270' from DER, left and right of centerline, up to 55' AGL/1441' MSL.

Transmission towers beginning 5499' from DER, left and right of centerline, up to 104' AGL/1479' MSL.

## MOUNT JOY/MARIETTA, PA

### DONEGAL SPRINGS AIRPARK (N71)

TAKEOFF MINIMUMS AND (OBSTACLE) DEPARTURE PROCEDURES

AMDT 2 20DEC07 (07354) (FAA)

DEPARTURE PROCEDURE:

**Rwy 10**, climb heading 094° to 1300 before turning southwest.**Rwy 28**, climb heading 274° to 1900 before turning south.

TAKEOFF OBSTACLE NOTES:

**Rwy 10**, tree 433' from DER, 487' right of centerline, 100' AGL/519' MSL.

# TAKEOFF MINIMUMS, (OBSTACLE) DEPARTURE PROCEDURES, AND DIVERSE VECTOR AREA (RADAR VECTORS)

23334

NE-4



# TAKEOFF MINIMUMS, (OBSTACLE) DEPARTURE PROCEDURES, AND DIVERSE VECTOR AREA (RADAR VECTORS)

23334

## MOUNT POCONO, PA

### POCONO MOUNTAINS RGNL (MPO)

#### TAKEOFF MINIMUMS AND (OBSTACLE) DEPARTURE PROCEDURES

AMDT 2 18NOV10 (21280) (FAA)

##### TAKEOFF MINIMUMS:

**Rwy 5**, 300-2 or std. w/min. climb of 234' per NM to 2300.

**Rwy 31**, 300-1½ or std. w/min. climb of 266' per NM to 2200.

##### DEPARTURE PROCEDURE:

**Rwy 5**, climb heading 050° to 2500 before proceeding on course.

**Rwy 13**, climb heading 128° to 2500 before proceeding on course.

**Rwy 23**, climb heading 230° to 2500 before proceeding on course.

**Rwy 31**, climb heading 308° to 2500 before proceeding on course.

##### TAKEOFF OBSTACLE NOTES:

**Rwy 5**, trees beginning 4' from DER, 493' right of centerline, up to 100' AGL/2039' MSL.

Trees beginning 19' from DER, 499' left of centerline, up to 100' AGL/2019' MSL.

Tower 1.5 NM from DER, 2728' left of centerline, 177' AGL/2200' MSL.

Vehicles 754' from DER, 55' left of centerline, up to 17' MSL/1957' MSL.

**Rwy 13**, trees beginning 185' from DER, 52' left of centerline, up to 100' AGL/1989' MSL.

Trees beginning 1628' from DER, 187' right of centerline, up to 100' AGL/1989' MSL.

**Rwy 23**, trees beginning 14' from DER, 347' left of centerline, up to 100' AGL/1945' MSL.

Trees beginning 73' from DER, 20' right of centerline, up to 100' AGL/1936' MSL.

**Rwy 31**, trees beginning 7' from DER, 287' right of centerline, up to 100' AGL/2079' MSL.

Trees beginning 580' from DER, 245' left of centerline, up to 100' AGL/1969' MSL.

Railroad tracks 1459' from DER, up to 23' AGL/1903' MSL.

## MUIR AHP (KMUJ)

### FORT INDIANTOWN GAP, PA

#### TAKEOFF MINIMUMS AND (OBSTACLE) DEPARTURE PROCEDURES

AMDT 1 18MAY23 (23278) (USA)

##### DEPARTURE PROCEDURE:

**Rwy 7**, climbing right turn to 190° bearing from BZJ NDB to 1900 before proceeding on course.

**Rwy 25**, climbing left turn to 190° bearing from BZJ NDB to 1800 before proceeding on course.

##### TAKEOFF OBSTACLE NOTES:

**Rwy 7**, power pole 893' from DER, 90' right of centerline, 504' MSL.

Trees 181' to 920' from DER, 403' to 426' left of centerline, up to 518' MSL.

Trees 4' from DER, 324' right of centerline, 518' MSL.

Trees 321' to 2317' from DER, 117' to 363' right of centerline, up to 548' MSL.

**Rwy 25**, terrain 2662' from DER, 1213' right of centerline, 537' MSL.

Bldgs 866' to 2708' from DER, 17' to 705' right of centerline, up to 531' MSL.

Bldgs 498' to 822' from DER, 497' to 629' left of centerline, up to 493' MSL.

Power poles 1069' to 1469' from DER, 9' to 583' right of centerline, up to 513' MSL.

Power poles 1192' to 1594' from DER, 15' to 135' left of centerline, up to 508' MSL.

Smokestack 977' from DER, 131' right of centerline, 485' MSL.

Trees 39' from DER, 388' right of centerline, 507' MSL.

Trees 1104' to 3088' from DER, 134' to 1124' right of centerline, up to 589' MSL.

Trees 352' to 2218' from DER, 132' to 458' left of centerline, up to 556' MSL.

Fence/line 215' from DER, 474' right of centerline, 487' MSL.

## MYERSTOWN, PA

### DECK (9D4)

#### TAKEOFF MINIMUMS AND (OBSTACLE) DEPARTURE PROCEDURES

ORIG 18JAN07 (07018) (FAA)

##### DEPARTURE PROCEDURE:

**Rwy 19**, climb heading 174° to 1600 before proceeding on course.

##### TAKEOFF OBSTACLE NOTES:

**Rwy 1**, tree 315' from DER, 579' right of centerline, 41' AGL/570' MSL.

Pole 697' from DER, 621' right of centerline, 31' AGL/553' MSL.

Tree 878' from DER, 616' right of centerline, 56' AGL/572' MSL.

## NEW CASTLE, PA

### NEW CASTLE MUNI (UCP)

#### TAKEOFF MINIMUMS AND (OBSTACLE) DEPARTURE PROCEDURES

AMDT 1 20MAR03 (03079) (FAA)

##### TAKEOFF MINIMUMS:

**Rwy 13**, 300-1 or std. with a min. climb of 350' per NM to 1400.

##### TAKEOFF OBSTACLE NOTES:

**Rwy 5**, tree 785' from DER, 196' right of centerline, 32' AGL/1029' MSL.

**Rwy 13**, trees 4087' from DER, 1531' right of centerline, 100' AGL/1249' MSL.

Building 262' from DER, 179' left of centerline, 24' AGL/1088' MSL.

**Rwy 31**, tree 497' from DER, 18' right of centerline, 28' AGL/1044' MSL.

# TAKEOFF MINIMUMS, (OBSTACLE) DEPARTURE PROCEDURES, AND DIVERSE VECTOR AREA (RADAR VECTORS)

23334

NE-4

# TAKEOFF MINIMUMS, (OBSTACLE) DEPARTURE PROCEDURES, AND DIVERSE VECTOR AREA (RADAR VECTORS)

23334

## PALMYRA, PA

### REIGLE FLD (58N)

#### TAKEOFF MINIMUMS AND (OBSTACLE) DEPARTURE PROCEDURES

ORIG-A 15DEC11 (22083) (FAA)

#### TAKEOFF MINIMUMS:

**Rwys 13, 31**, NA at night.

**Rwy 13**, 1000-3 w/min. climb of 373' to 2500 or 1600-2½ for climb in visual conditions.

**Rwy 31**, 1000-3 or 1600-2½ for climb in visual conditions.

#### DEPARTURE PROCEDURE:

**Rwy 13**, climb heading 127° to 2500 before proceeding on course or for climb in visual conditions: cross Reigle Fld airport at or above 1900 MSL before proceeding on course.

**Rwy 31**, climb heading 307° to 2500 before proceeding on course or for climb in visual conditions: cross Reigle Fld airport at or above 1900 MSL before proceeding on course.

#### TAKEOFF OBSTACLE NOTES:

**Rwy 13**, vehicles/buildings/power lines beginning 60' from DER on centerline, up to 200' AGL/699' MSL.

Terrain beginning 2 NM from DER, 50' right of centerline, up to 1160' MSL.

Signs beginning 165' from DER, 244' right of centerline, up to 9' AGL/501' MSL.

**Rwy 31**, buildings/power lines beginning 1250' from DER, on centerline, up to 200' AGL/679' MSL.

## PARKERSBURG, WV

### MID-OHIO VALLEY RGNL (PKB)

#### TAKEOFF MINIMUMS AND (OBSTACLE) DEPARTURE PROCEDURES

AMDT 3 20JUN19 (19171) (FAA)

#### TAKEOFF MINIMUMS:

**Rwy 21**, 300-1¼ or std. w/min. climb of 400' per NM to 1100.

**Rwy 28**, 500-3 or std. w/min. climb of 285' per NM to 1500.

#### TAKEOFF OBSTACLE NOTES:

**Rwy 3**, trees beginning 49' from DER, 3' left of centerline, up to 65' AGL/911' MSL.

Tree 93' from DER, 61' right of centerline, 8' AGL/864' MSL.

Trees beginning 108' from DER, 122' right of centerline, up to 13' AGL/866' MSL.

Trees beginning 223' from DER, 191' right of centerline, up to 878' MSL.

Trees beginning 373' from DER, 317' right of centerline, up to 882' MSL.

Tree 1269' from DER, 490' right of centerline, 897' MSL.

Tree 1415' from DER, 437' right of centerline, 905' MSL.

Trees beginning 1540' from DER, 24' right of centerline, up to 911' MSL.

Trees beginning 1767' from DER, 17' left of centerline, up to 67' AGL/912' MSL.

Trees beginning 1796' from DER, 41' left of centerline, up to 72' AGL/913' MSL.

Trees beginning 1821' from DER, 12' right of centerline, up to 61' AGL/914' MSL.

Trees beginning 1841' from DER, 19' left of centerline, up to 67' AGL/914' MSL.

Trees beginning 1856' from DER, 35' right of centerline, up to 58' AGL/915' MSL.

Trees beginning 1876' from DER, 6' left of centerline, up to 65' AGL/916' MSL.

Trees beginning 1877' from DER, 105' right of centerline, up to 60' AGL/920' MSL.

Trees beginning 1885' from DER, 55' right of centerline, up to 58' AGL/921' MSL.

Trees beginning 1911' from DER, 6' right of centerline, up to 59' AGL/925' MSL.

Trees beginning 1967' from DER, 96' right of centerline, up to 58' AGL/926' MSL.

Trees beginning 1980' from DER, 82' right of centerline, up to 70' AGL/929' MSL.

Trees beginning 1990' from DER, 177' right of centerline, up to 64' AGL/931' MSL.

Trees beginning 2017' from DER, 5' right of centerline, up to 89' AGL/945' MSL.

Trees beginning 2141' from DER, 1' left of centerline, up to 917' MSL.

Tree 2242' from DER, 44' left of centerline, 88' AGL/919' MSL.

Tree 2694' from DER, 84' left of centerline, 86' AGL/927' MSL.

Trees beginning 2725' from DER, 28' left of centerline, up to 82' AGL/931' MSL.

Trees beginning 2772' from DER, 49' left of centerline, up to 75' AGL/932' MSL.

Trees beginning 2922' from DER, 193' right of centerline, up to 82' AGL/946' MSL.

Trees beginning 2938' from DER, 185' right of centerline, up to 86' AGL/949' MSL.

Trees beginning 2989' from DER, 98' right of centerline, up to 96' AGL/952' MSL.

Trees beginning 3112' from DER, 7' left of centerline, up to 102' AGL/948' MSL.

Trees beginning 3243' from DER, 613' right of centerline, up to 961' MSL.

**Rwy 10**, tree 51' from DER, 444' left of centerline, 843' MSL.

Tree 83' from DER, 346' left of centerline, 852' MSL.

Trees beginning 106' from DER, 104' left of centerline, up to 24' AGL/856' MSL.

Tree 337' from DER, 239' right of centerline, 857' MSL.

Trees beginning 354' from DER, 38' left of centerline, up to 869' MSL.

Trees beginning 377' from DER, 145' right of centerline, up to 867' MSL.

Tree 473' from DER, 387' right of centerline, 874' MSL.

Tree 473' from DER, 163' right of centerline, 81' AGL/882' MSL.

Trees beginning 482' from DER, 112' right of centerline, up to 87' AGL/885' MSL.

Trees beginning 536' from DER, 17' left of centerline, up to 888' MSL.

Trees beginning 573' from DER, 106' right of centerline, up to 100' AGL/892' MSL.

Tree, tank, stack, tower beginning 625' from DER, 114' right of centerline, up to 893' MSL.

CON'T

22 FEB 2024 to 21 MAR 2024

22 FEB 2024 to 21 MAR 2024

# TAKEOFF MINIMUMS, (OBSTACLE) DEPARTURE PROCEDURES, AND DIVERSE VECTOR AREA (RADAR VECTORS)

23334

NE-4

# TAKEOFF MINIMUMS, (OBSTACLE) DEPARTURE PROCEDURES, AND DIVERSE VECTOR AREA (RADAR VECTORS)

23334

## PARKERSBURG, WV (CON'T) MID-OHIO VALLEY RGNL (PKB) (CON'T)

**Rwy 21**, tree 50' from DER, 488' left of centerline, 805' MSL.  
Tree, sign beginning 65' from DER, 168' left of centerline, up to 811' MSL.  
Trees beginning 91' from DER, 312' right of centerline, up to 26' AGL/818' MSL.  
Trees beginning 192' from DER, 405' left of centerline, up to 840' MSL.  
Tree 678' from DER, 654' right of centerline, 831' MSL.  
Tree 903' from DER, 685' right of centerline, 843' MSL.  
Tree 957' from DER, 614' right of centerline, 848' MSL.  
Trees beginning 966' from DER, 614' right of centerline, up to 860' MSL.  
Tree 1323' from DER, 828' left of centerline, 843' MSL.  
Tree 2738' from DER, 1142' left of centerline, 872' MSL.  
Trees beginning 2806' from DER, 1065' right of centerline, up to 880' MSL.  
Tree 2894' from DER, 1016' right of centerline, 882' MSL.  
Tree 2935' from DER, 1246' right of centerline, 897' MSL.  
Trees beginning 2974' from DER, 996' right of centerline, up to 911' MSL.  
Trees beginning 3049' from DER, 182' left of centerline, up to 53' AGL/885' MSL.  
Trees beginning 3084' from DER, 816' right of centerline, up to 944' MSL.  
Tree 3112' from DER, 301' left of centerline, 54' AGL/886' MSL.  
Trees beginning 3120' from DER, 193' left of centerline, up to 49' AGL/889' MSL.  
Trees beginning 3231' from DER, 175' left of centerline, up to 44' AGL/891' MSL.  
Trees beginning 3246' from DER, 400' right of centerline, up to 945' MSL.  
Tree 3334' from DER, 1015' right of centerline, 946' MSL.  
Trees beginning 3348' from DER, 2' right of centerline, up to 103' AGL/969' MSL.  
Trees beginning 3376' from DER, 248' left of centerline, up to 42' AGL/895' MSL.  
Trees beginning 3443' from DER, 202' left of centerline, up to 49' AGL/897' MSL.  
Trees beginning 3637' from DER, 428' left of centerline, up to 910' MSL.  
Trees beginning 3764' from DER, 373' left of centerline, up to 912' MSL.  
Tree 3907' from DER, 921' left of centerline, 921' MSL.  
Trees beginning 3941' from DER, 445' left of centerline, up to 929' MSL.  
Trees beginning 4053' from DER, 3' left of centerline, up to 937' MSL.  
Tree 1 NM from DER, 2126' right of centerline, 956' MSL.  
**Rwy 28**, tree 32' from DER, 418' right of centerline, 843' MSL.  
Tree 76' from DER, 292' left of centerline, 838' MSL.  
Tree 96' from DER, 402' right of centerline, 862' MSL.  
Tree, fence beginning 114' from DER, 341' right of centerline, up to 75' AGL/881' MSL.  
Tree 221' from DER, 298' left of centerline, 841' MSL.  
Tree 403' from DER, 490' right of centerline, 882' MSL.  
Trees beginning 522' from DER, 22' right of centerline, up to 885' MSL.  
Tree 560' from DER, 14' left of centerline, 18' AGL/846' MSL.  
Trees beginning 594' from DER, 12' left of centerline, up to 35' AGL/859' MSL.  
Trees beginning 637' from DER, 5' left of centerline, up to 39' AGL/863' MSL.  
Trees beginning 809' from DER, 158' left of centerline, up to 46' AGL/864' MSL.  
Tower beginning 2.3 NM from DER, 935' left of centerline, up to 319' AGL/1326' MSL.  
Tower 2.4 NM from DER, 3118' left of centerline, 207' AGL/1215' MSL.

## PERKASIE, PA PENNRRIDGE (CKZ)

### TAKEOFF MINIMUMS AND (OBSTACLE) DEPARTURE PROCEDURES AMD T 1 30JAN20 (20030) (FAA)

#### TAKEOFF MINIMUMS:

**Rwy 26**, 400-3 or std. w/min. climb of 248' per NM to 1100.

#### DEPARTURE PROCEDURE:

**Rwy 26**, climb on heading 262° to 1100 before proceeding on course.

#### TAKEOFF OBSTACLE NOTES:

**Rwy 8**, fence 25' from DER, 2' left of centerline, 11' AGL/576' MSL.  
Tree 68' from DER, 315' left of centerline, 616' MSL.  
Tree, building, pole beginning 89' from DER, 277' right of centerline, up to 652' MSL.  
Trees beginning 134' from DER, 252' left of centerline, up to 629' MSL.  
Trees beginning 242' from DER, 31' left of centerline, up to 642' MSL.  
Trees, poles beginning 783' from DER, 79' right of centerline, up to 655' MSL.  
Trees beginning 880' from DER, 175' right of centerline, up to 660' MSL.  
Trees, poles beginning 957' from DER, 9' right of centerline, up to 664' MSL.  
Trees beginning 1681' from DER, 43' left of centerline, up to 647' MSL.  
Trees beginning 1723' from DER, 93' left of centerline, up to 654' MSL.  
Tree 1848' from DER, 223' left of centerline, 659' MSL.  
Trees beginning 1894' from DER, 2' left of centerline, up to 661' MSL.  
Trees beginning 1946' from DER, 1' left of centerline, up to 665' MSL.  
Trees beginning 2480' from DER, 14' left of centerline, up to 666' MSL.

**CON'T**

# TAKEOFF MINIMUMS, (OBSTACLE) DEPARTURE PROCEDURES, AND DIVERSE VECTOR AREA (RADAR VECTORS)

23334

NE-4

# TAKEOFF MINIMUMS, (OBSTACLE) DEPARTURE PROCEDURES, AND DIVERSE VECTOR AREA (RADAR VECTORS)

23334

## PERKASIE, PA (CON'T)

### PENNRIDGE (CKZ) (CON'T)

**Rwy 26**, tree 12' from DER, 501' right of centerline, 572' MSL.  
Sign 18' from DER, 116' left of centerline, 522' MSL.  
Trees beginning 72' from DER, 18' right of centerline, up to 585' MSL.  
Vegetation 75' from DER, 328' left of centerline, 523' MSL.  
Trees, vegetation beginning 89' from DER, 202' left of centerline, up to 555' MSL.  
Tree 299' from DER, 455' left of centerline, 558' MSL.  
Trees beginning 307' from DER, 14' left of centerline, up to 582' MSL.  
Trees beginning 677' from DER, 437' left of centerline, up to 583' MSL.  
Trees, poles beginning 699' from DER, 50' left of centerline, up to 600' MSL.  
Trees, buildings beginning 1258' from DER, 0' left of centerline, up to 601' MSL.  
Pole 3553' from DER, 1217' left of centerline, 613' MSL.  
Pole 3593' from DER, 1248' left of centerline, 614' MSL.  
Pole 3798' from DER, 1289' left of centerline, 617' MSL.  
Pole 3860' from DER, 1315' left of centerline, 634' MSL.  
Trees beginning 3895' from DER, 1516' right of centerline, up to 623' MSL.  
Tree 6003' from DER, 2053' right of centerline, 670' MSL.  
Tree 1 NM from DER, 1954' right of centerline, 673' MSL.  
Tree 1.9 NM from DER, 2496' right of centerline, 814' MSL.  
Trees beginning 1.9 NM from DER, 1885' right of centerline, up to 846' MSL.  
Trees beginning 1.9 NM from DER, 1756' right of centerline, up to 859' MSL.  
Tower 2.2 NM from DER, 4142' right of centerline, 207' AGL/947' MSL.  
Tower 2.3 NM from DER, 3989' right of centerline, 881' MSL.

## PETERSBURG, WV

### GRANT COUNTY (W99)

#### TAKEOFF MINIMUMS AND (OBSTACLE) DEPARTURE PROCEDURES AMD T 1 19SEP13 (13262) (FAA)

##### TAKEOFF MINIMUMS:

**Rwys 13, 31**, 2400-3 for climb in visual condition.

##### DEPARTURE PROCEDURE:

For climb in visual conditions, cross Grant County airport Northeast bound at or above 3200. Then climb to 5000 on ESL R-214 direct ESL VOR/DME. When executing VCOA, notify ATC prior to departure.

##### TAKEOFF OBSTACLE NOTES:

**Rwy 13**, trees 517' from DER, 609' left of centerline, up to 70' AGL /1029' MSL.  
Trees beginning 3042' from DER, 1304' right of centerline, up to 100' AGL /1099' MSL.  
**Rwy 31**, trees 182' from DER, 546' right of centerline, up to 100' AGL/1099' MSL.  
Vehicles on road 1651' from DER, 927' right of centerline, up to 15' AGL/1054' MSL.  
Building 2553' from DER, 414' right of centerline, 30' AGL/1029' MSL.  
Trees beginning 3642' from DER, 651' left of centerline, up to 100' AGL/1139' MSL.

## PHILADELPHIA, PA

### NORTHEAST PHILADELPHIA (PNE)

#### TAKEOFF MINIMUMS AND (OBSTACLE) DEPARTURE PROCEDURES ORIG 14FEB08 (23082) (FAA)

##### TAKEOFF MINIMUMS:

**Rwy 33**, 200-1/4 or std. w/min. climb of 223' per NM to 400, or alternatively, with std. takeoff minimums and a normal 200'/NM climb gradient, takeoff must occur no later than 1600' prior to DER.

##### TAKEOFF OBSTACLE NOTES:

**Rwy 6**, trees 1355' from DER, 803' left of centerline, 58' AGL/179' MSL.  
Trees 1576' from DER, 835' left of centerline, 44' AGL/165' MSL.  
**Rwy 15**, vehicles on roads beginning 540' from DER, on centerline, up to 15' AGL/134' MSL.  
Trees beginning 592' from DER, 42' left of centerline, up to 74' AGL/166' MSL.  
Trees beginning 928' from DER, 213' right of centerline, up to 64' AGL/173' MSL.  
**Rwy 24**, trees beginning 198' from DER, 198' left of centerline, up to 38' AGL/158' MSL.  
Vehicle on road 450' from DER, on centerline, 15' AGL/134' MSL.  
Tank and trees beginning 2343' from DER, 577' left of centerline, up to 91' AGL/200' MSL.  
Bushes and trees beginning 118' from DER, 182' right of centerline, up to 26' AGL/137' MSL.  
Trees beginning 1325' from DER, 220' right of centerline, up to 77' AGL/197' MSL.  
**Rwy 33**, vehicle on road 2050' from DER, on centerline, 15' AGL/174' MSL.  
Bushes and trees beginning 491' from DER, 29' left of centerline, up to 66' AGL/225' MSL.  
Obstruction light transmission towers, beginning 5872' from DER, 401' left of centerline, up to 125' AGL/284' MSL.  
Bushes and trees beginning 636' from DER, 185' right of centerline, up to 57' AGL/215' MSL.

22 FEB 2024 to 21 MAR 2024

22 FEB 2024 to 21 MAR 2024

# TAKEOFF MINIMUMS, (OBSTACLE) DEPARTURE PROCEDURES, AND DIVERSE VECTOR AREA (RADAR VECTORS)

23334

NE-4

# TAKEOFF MINIMUMS, (OBSTACLE) DEPARTURE PROCEDURES, AND DIVERSE VECTOR AREA (RADAR VECTORS)

23334

## PHILADELPHIA, PA (CON'T)

### PHILADELPHIA INTL (PHL)

#### TAKEOFF MINIMUMS AND (OBSTACLE) DEPARTURE PROCEDURES

AMDT 11 25FEB21 (21056) (FAA)

#### TAKEOFF MINIMUMS:

**Rwy 26**, NA - ATC request.

**Rwy 8**, std. w/ min. climb of 300' per NM to 1500.

**Rwy 9L**, std. w/ min. climb of 280' per NM to 1500.

**Rwy 9R**, std. w/ min. climb of 250' per NM to 1500.

**Rwy 17**, 300-1 or std. w/ min. climb of 611' per NM to 300.

**Rwy 35**, std. w/ min. climb of 280' per NM to 1500.

#### TAKEOFF OBSTACLE NOTES:

**Rwy 8**, poles beginning 5' from DER, 15' left of centerline, up to 1' AGL/37' MSL.

Poles beginning 10' from DER, 13' right of centerline, up to 1' AGL/37' MSL.

General utility and fence beginning 52' from DER, 250' right of centerline, up to 10' AGL/42' MSL.

Tree 276' from DER, 563' left of centerline, 57' AGL/58' MSL.

Tree 445' from DER, 554' right of centerline, 43' AGL/50' MSL.

Trees beginning 506' from DER, 536' right of centerline, up to 49' AGL/56' MSL.

Trees beginning 612' from DER, 75' right of centerline, up to 68' AGL/74' MSL.

Tree 2834' from DER, 702' right of centerline, 114' AGL/119' MSL.

**Rwy 9L**, poles beginning 9' from DER, 15' right of centerline, up to 2' AGL/12' MSL.

Poles beginning 9' from DER, 14' left of centerline, up to 1' AGL/12' MSL.

Asde pole and general utility beginning 103' from DER, 460' right of centerline, up to 8' AGL/15' MSL.

Tree 600' from DER, 619' left of centerline, 23' AGL/28' MSL.

Tree 969' from DER, 655' left of centerline, 35' AGL/35' MSL.

Pole 1014' from DER, 736' right of centerline, 29' AGL/36' MSL.

Tree 1431' from DER, 784' right of centerline, 40' AGL/47' MSL.

Tree 1943' from DER, 985' right of centerline, 55' AGL/59' MSL.

Tree 2043' from DER, 993' right of centerline, 53' AGL/62' MSL.

Trees beginning 2118' from DER, 970' right of centerline, up to 61' AGL/73' MSL.

Vertical structure 3543' from DER, 1120' right of centerline, 94' AGL/103' MSL.

**Rwy 9R**, lighting 154' from DER, on centerline, 7' AGL/15' MSL.

Tree 2177' from DER, 1067' right of centerline, 54' AGL/67' MSL.

Vertical structure 3736' from DER, 1217' right of centerline, 109' MSL.

Antenna 3845' from DER, 1052' right of centerline, 143' AGL/143' MSL.

Tower and antenna beginning 3887' from DER, 658' right of centerline, up to 140' AGL/144' MSL.

**Rwy 17**, pole 2' from DER, 55' right of centerline, 1' AGL/13' MSL.

Terrain and lighting beginning 2' from DER, 113' right of centerline, up to 20' MSL.

Lighting 37' from DER, 112' left of centerline, 4' AGL/14' MSL.

Terrain 86' from DER, 61' left of centerline, 20' MSL.

Terrain 202' from DER, 483' right of centerline, 23' MSL.

Tree and vehicle on road beginning 630' from DER, 647' left of centerline, up to 34' AGL/48' MSL.

Tree, pole, and vehicle on road beginning 701' from DER, 341' left of centerline, up to 45' AGL/58' MSL.

Trees beginning 985' from DER, 521' left of centerline, up to 51' AGL/61' MSL.

Tree and pole beginning 1005' from DER, 228' left of centerline, up to 55' AGL/68' MSL.

Tree 1097' from DER, 390' right of centerline, 46' MSL.

Tree and pole beginning 1127' from DER, 11' left of centerline, up to 60' AGL/73' MSL.

Tree 1299' from DER, 126' right of centerline, 37' AGL/50' MSL.

Trees beginning 1310' from DER, 63' right of centerline, up to 38' AGL/51' MSL.

Tree 1382' from DER, 194' right of centerline, 46' AGL/54' MSL.

Tree 1387' from DER, 171' right of centerline, 48' AGL/55' MSL.

Tree 1388' from DER, 214' right of centerline, 46' AGL/57' MSL.

Trees beginning 1400' from DER, 5' right of centerline, up to 49' AGL/60' MSL.

Tree 1744' from DER, 931' right of centerline, 63' AGL/70' MSL.

Transient ship 2323' from DER, 2' right of centerline, 190' AGL/190' MSL.

**Rwy 27L**, pole and vehicle on road beginning abeam DER, 14' left of centerline, up to 1' AGL/21' MSL.

Vehicle on road and pole beginning 6' from DER, 20' right of centerline, up to 21' MSL.

Trees beginning 234' from DER, 531' right of centerline, up to 42' AGL/47' MSL.

Trees beginning 313' from DER, 391' right of centerline, up to 45' AGL/51' MSL.

Trees beginning 631' from DER, 619' left of centerline, up to 41' AGL/41' MSL.

Trees beginning 873' from DER, 609' right of centerline, up to 39' AGL/54' MSL.

Tree 2440' from DER, 644' right of centerline, 76' AGL/82' MSL.

Tree 2631' from DER, 1156' right of centerline, 101' AGL/105' MSL.

**Rwy 27R**, terrain and pole beginning 2' from DER, 24' right of centerline, up to 20' MSL.

Poles beginning 4' from DER, 5' left of centerline, up to 3' AGL/14' MSL.

Terrain 78' from DER, 111' left of centerline, up to 20' MSL.

**Rwy 35**, terrain and pole beginning 3' from DER, 35' left of centerline, up to 10' MSL.

Poles beginning 15' from DER, 4' right of centerline, up to 2' AGL/9' MSL.

Fence beginning 115' from DER, 382' left of centerline, up to 10' AGL/17' MSL.

Pole and building beginning 341' from DER, 360' left of centerline, up to 23' AGL/29' MSL.

Fence 444' from DER, 2' right of centerline, 13' AGL/20' MSL.

Pole 480' from DER, 587' right of centerline, 21' AGL/25' MSL.

Poles beginning 532' from DER, 458' right of centerline, up to 22' AGL/26' MSL.

Pole, tree, vehicle on road, and sign beginning 595' from DER, 299' left of centerline, up to 53' AGL/58' MSL.

CON'T

22 FEB 2024 to 21 MAR 2024

22 FEB 2024 to 21 MAR 2024

# TAKEOFF MINIMUMS, (OBSTACLE) DEPARTURE PROCEDURES, AND DIVERSE VECTOR AREA (RADAR VECTORS)

23334

# TAKEOFF MINIMUMS, (OBSTACLE) DEPARTURE PROCEDURES, AND DIVERSE VECTOR AREA (RADAR VECTORS)

23334

## PHILADELPHIA, PA (CON'T)

### PHILADELPHIA INTL (PHL) (CON'T)

**Rwy 35 (CON'T)**, pole 722' from DER, 604' right of centerline, 20' AGL/27' MSL.  
 Pole 758' from DER, 95' right of centerline, 25' AGL/31' MSL.  
 Buildings beginning 761' from DER, 644' right of centerline, up to 29' AGL/35' MSL.  
 Building 852' from DER, 728' right of centerline, 25' AGL/36' MSL.  
 Pole and tree beginning 1072' from DER, 91' right of centerline, up to 47' AGL/52' MSL.  
 Vehicle on road, sign, pole, and tree beginning 1398' from DER, 625' right of centerline, up to 61' MSL.  
 Tree 1922' from DER, 949' right of centerline, 57' AGL/64' MSL.  
 Tree 2067' from DER, 938' right of centerline, 58' AGL/65' MSL.  
 Tree 2087' from DER, 989' right of centerline, 60' AGL/66' MSL.  
 Pole 2167' from DER, 200' right of centerline, 62' AGL/68' MSL.  
 Tree and building beginning 2206' from DER, 92' right of centerline, up to 66' AGL/72' MSL.  
 Tree 2208' from DER, 808' left of centerline, 67' AGL/75' MSL.  
 Trees beginning 2215' from DER, 728' left of centerline, up to 74' AGL/82' MSL.  
 Trees beginning 2248' from DER, 606' left of centerline, up to 81' AGL/88' MSL.  
 Trees beginning 2272' from DER, 700' left of centerline, up to 87' AGL/93' MSL.  
 Tree 2325' from DER, 837' left of centerline, 88' AGL/94' MSL.  
 Trees beginning 2348' from DER, 686' left of centerline, up to 89' AGL/95' MSL.  
 Trees beginning 2536' from DER, 854' left of centerline, up to 91' AGL/97' MSL.  
 Pole, tree, and transmission line beginning 877' right of centerline, 74' AGL/84' MSL.  
 Pole and transmission line beginning 3882' from DER, 643' right of centerline, up to 105' AGL/111' MSL.  
 Pole, transmission line, and catenary beginning 4065' from DER, 920' right of centerline, up to 118' AGL/125' MSL.  
 Transmission line beginning 4249' from DER, 1202' right of centerline, up to 121' AGL/129' MSL.

## WINGS FLD (LOM)

### TAKEOFF MINIMUMS AND (OBSTACLE) DEPARTURE PROCEDURES

AMDT 2 23SEP10 (22083) (FAA)

#### DEPARTURE PROCEDURE:

**Rwy 24**, climb heading 245° to 1100 before turning left.

#### TAKEOFF OBSTACLE NOTES:

**Rwy 6**, trees beginning 54' from DER, 103' left of centerline, up to 106' AGL/389' MSL.

Trees beginning 513' from DER, 110' right of centerline, up to 107' AGL/347' MSL.

**Rwy 24**, multiple trees, towers, buildings, flag poles, vehicles on road, and rising terrain beginning at DER, left and right of centerline, up to 160' AGL/444' MSL.

## PHILIPPI, WV

### PHILIPPI/BARBOUR COUNTY RGNL (79D)

#### TAKEOFF MINIMUMS AND (OBSTACLE) DEPARTURE PROCEDURES

ORIG 05JUN08 (08157) (FAA)

#### DEPARTURE PROCEDURE:

**Rwy 8**, climb heading 083° to 3300 before turning south.

#### TAKEOFF OBSTACLE NOTES:

**Rwy 8**, trees beginning 108' from DER, 118' right of centerline, up to 100' AGL/1799' MSL.

**Rwy 26**, trees beginning 504' from DER, 220' left of centerline, up to 100' AGL/1779' MSL.

## PHILIPSBURG, PA

### MID-STATE (PSB)

#### TAKEOFF MINIMUMS AND (OBSTACLE) DEPARTURE PROCEDURES

AMDT 2A 08SEP22 (22251) (FAA)

#### TAKEOFF MINIMUMS:

**Rwy 6**, std. w/min. climb of 250' per NM to 2600 or 1300-3 for climb in visual conditions.

**Rwy 16**, 400-2 or std. w/min. climb of 330' per NM to 2500.

**Rwy 24**, 800-3 or std. w/min. climb of 308' per NM to 2400.

#### DEPARTURE PROCEDURE:

**Rwy 6**, climbing left turn heading 340° to 2900 before proceeding on course.

**Rwy 16**, climb on heading 167° to 2800 before proceeding on course.

**Rwy 24**, climb on heading 240° to 2800 before proceeding on course.

**Rwy 34**, climb on heading 347° to 2800 before proceeding on course.

#### VCOA:

**Rwy 6**, obtain ATC approval for VCOA when requesting IFR clearance. Climb in visual conditions to cross Mid-State airport at or above 3100 before proceeding on course.

#### TAKEOFF OBSTACLE NOTES:

**Rwy 6**, trees beginning 24' from DER, 182' right of centerline, up to 1959' MSL.

Trees beginning 336' from DER, 14' left of centerline, up to 1940' MSL.

Trees beginning 536' from DER, 252' left of centerline, up to 1950' MSL.

Pole 2.3 NM from DER, 3204' left of centerline, 110' AGL/2356' MSL.

**Rwy 16**, trees beginning 7' from DER, 276' right of centerline, up to 2004' MSL.

Trees beginning 51' from DER, 252' left of centerline, up to 1964' MSL.

Tree 983' from DER, 535' left of centerline, 1983' MSL.

Trees beginning 1183' from DER, 17' left of centerline, up to 1995' MSL.

Pole 1 NM from DER, 104' left of centerline, 53' AGL/2097' MSL.

CON'T

# TAKEOFF MINIMUMS, (OBSTACLE) DEPARTURE PROCEDURES, AND DIVERSE VECTOR AREA (RADAR VECTORS)

23334

NE-4

# TAKEOFF MINIMUMS, (OBSTACLE) DEPARTURE PROCEDURES, AND DIVERSE VECTOR AREA (RADAR VECTORS)

23334

## PHILIPSBURG, PA (CON'T)

### MID-STATE (PSB) (CON'T)

**Rwy 16 (CON'T)**, tree 1.1 NM from DER, 980' left of centerline, 2165' MSL.  
Tree 1.2 NM from DER, 194' left of centerline, 2175' MSL.  
Trees beginning 1.5 NM from DER, 99' left of centerline, up to 2309' MSL.  
Pole, tree beginning 1.6 NM from DER, 5' right of centerline, up to 2294' MSL.  
**Rwy 24**, trees beginning 83' from DER, 130' left of centerline, up to 1918' MSL.  
Tree 572' from DER, 165' right of centerline, 1882' MSL.  
Tree 574' from DER, 162' right of centerline, 1890' MSL.  
Trees beginning 972' from DER, 145' left of centerline, up to 1952' MSL.  
Tree 4367' from DER, 230' right of centerline, 1998' MSL.  
Tree 4702' from DER, 95' right of centerline, 2011' MSL.  
Tree 5153' from DER, 829' right of centerline, 2052' MSL.  
Tree 5266' from DER, 438' left of centerline, 2043' MSL.  
Tree 5381' from DER, 859' left of centerline, 2074' MSL.  
Tree 5465' from DER, 598' right of centerline, 2053' MSL.  
Tree 5821' from DER, 134' right of centerline, 2066' MSL.  
Tree 5852' from DER, 396' left of centerline, 2079' MSL.  
Tree 6004' from DER, 219' right of centerline, 2068' MSL.  
Tree 1.6 NM from DER, 401' right of centerline, 2122' MSL.  
**Rwy 34**, vehicles on road 70' from DER, 456' right of centerline, 1954' MSL.  
Terrain 196' from DER, 496' left of centerline, 1953' MSL.  
Vegetation 404' from DER, 298' left of centerline, 1958' MSL.  
Tree 494' from DER, 518' left of centerline, 1973' MSL.  
Tree 847' from DER, 651' right of centerline, 1972' MSL.  
Tree 1273' from DER, 691' left of centerline, 1985' MSL.  
Tree 2939' from DER, 780' left of centerline, 2022' MSL.

## PINEVILLE, WV

### KEE FLD (I16)

#### TAKEOFF MINIMUMS AND (OBSTACLE) DEPARTURE PROCEDURES

AMDT 2 20JUN19 (21280) (FAA)

##### TAKEOFF MINIMUMS:

**Rwy 8**, 700-2¼ w/min. climb of 330' per NM to 2900, or 1600-3 for VCOA.

**Rwy 26**, 400-2.

##### DEPARTURE PROCEDURE:

**Rwy 8**, climb heading 075° to 2600 before proceeding on course.

**Rwy 26**, climb heading 255° to 2600 before proceeding on course.

##### VCOA:

**Rwy 8**, obtain ATC approval for VCOA when requesting IFR clearance. Climb in visual conditions to cross Kee Fld at or above 3200 before proceeding on course.

##### TAKEOFF OBSTACLE NOTES:

**Rwy 8**, trees beginning 5' from DER, 11' left of centerline, up to 135' AGL/1964' MSL.  
Tree 140' from DER, 272' right of centerline, 135' AGL/1894' MSL.  
Tree 366' from DER, 357' right of centerline, 135' AGL/1910' MSL.  
Trees beginning 472' from DER, 72' right of centerline, up to 135' AGL/1940' MSL.  
Tree 579' from DER, 211' left of centerline, 135' AGL/1976' MSL.  
Trees beginning 685' from DER, 126' left of centerline, up to 135' AGL/1999' MSL.  
Trees beginning 819' from DER, 241' right of centerline, up to 135' AGL/1986' MSL.  
Trees beginning 911' from DER, 42' left of centerline, up to 135' AGL/2055' MSL.  
Trees beginning 1045' from DER, 41' right of centerline, up to 135' AGL/2071' MSL.  
Trees beginning 1243' from DER, 242' left of centerline, up to 135' AGL/2101' MSL.  
Trees beginning 1271' from DER, 11' right of centerline, up to 135' AGL/2101' MSL.  
Trees beginning 1576' from DER, 157' left of centerline, up to 135' AGL/2104' MSL.  
Trees beginning 1802' from DER, 73' left of centerline, up to 135' AGL/2134' MSL.  
Trees beginning 2028' from DER, 273' left of centerline, up to 135' AGL/2183' MSL.  
Trees beginning 2254' from DER, 19' left of centerline, up to 135' AGL/2193' MSL.  
Tree 2388' from DER, 464' right of centerline, 135' AGL/2114' MSL.  
Trees beginning 2402' from DER, 179' right of centerline, up to 135' AGL/2117' MSL.  
Trees 2614' from DER, 548' right of centerline, 135' AGL/2186' MSL.  
Trees beginning 2628' from DER, 264' right of centerline, up to 135' AGL/2193' MSL.  
Trees beginning 2840' from DER, 64' right of centerline, up to 135' AGL/2252' MSL.  
Trees beginning 3102' from DER, 25' right of centerline, up to 135' AGL/2302' MSL.  
Trees beginning 1.4 NM from DER, 721' left of centerline, up to 135' AGL/2242' MSL.  
Trees beginning 1.4 NM from DER, 469' right of centerline, up to 135' AGL/2337' MSL.  
Trees beginning 1.4 NM from DER, 636' left of centerline, up to 135' AGL/2284' MSL.  
Trees beginning 1.4 NM from DER, 921' left of centerline, up to 135' AGL/2311' MSL.  
Trees beginning 1.5 NM from DER, 1121' left of centerline, up to 135' AGL/2324' MSL.  
Trees beginning 1.5 NM from DER, 1405' left of centerline, up to 135' AGL/2337' MSL.  
Trees beginning 1.5 NM from DER, 1689' left of centerline, up to 135' AGL/2363' MSL.  
Trees beginning 1.5 NM from DER, 638' right of centerline, up to 135' AGL/2340' MSL.  
Trees beginning 1.5 NM from DER, 24' left of centerline, up to 135' AGL/2390' MSL.  
Tree 1.6 NM from DER, 2597' right of centerline, 135' AGL/2383' MSL.  
Trees beginning 1.6 NM from DER, 144' right of centerline, up to 135' AGL/2414' MSL.

CON'T

# TAKEOFF MINIMUMS, (OBSTACLE) DEPARTURE PROCEDURES, AND DIVERSE VECTOR AREA (RADAR VECTORS)

23334

NE-4

# TAKEOFF MINIMUMS, (OBSTACLE) DEPARTURE PROCEDURES, AND DIVERSE VECTOR AREA (RADAR VECTORS)

23334

## PINEVILLE, WV (CON'T)

### KEE FLD (I16) (CON'T)

**Rwy 8 (CON'T)**, tree 2.6 NM from DER, 349' left of centerline, 135' AGL/2307' MSL.  
**Rwy 26**, trees beginning 20' from DER, 25' right of centerline, up to 135' AGL/2014' MSL.  
 Trees beginning 82' from DER, 58' left of centerline, up to 135' AGL/1848' MSL.  
 Trees beginning 308' from DER, 174' left of centerline, up to 135' AGL/1864' MSL.  
 Trees beginning 867' from DER, 5' left of centerline, up to 135' AGL/1891' MSL.  
 Trees 1319' from DER, 289' left of centerline, 135' AGL/1930' MSL.  
 Trees 1425' from DER, 573' left of centerline, 135' AGL/1983' MSL.  
 Trees beginning 1524' from DER, 35' left of centerline, up to 135' AGL/2094' MSL.  
 Trees beginning 2203' from DER, 12' left of centerline, up to 135' AGL/2174' MSL.  
 Trees beginning 2810' from DER, 10' right of centerline, up to 135' AGL/2055' MSL.  
 Trees beginning 1.3 NM from DER, 371' right of centerline, up to 135' AGL/2061' MSL.  
 Trees beginning 1.3 NM from DER, 740' right of centerline, up to 135' AGL/2084' MSL.  
 Trees beginning 1.4 NM from DER, 225' right of centerline, up to 135' AGL/2174' MSL.  
 Tree 1.6 NM from DER, 272' right of centerline, 135' AGL/2014' MSL.

## PITTSBURGH, PA

### ALLEGHENY COUNTY (AGC)

#### TAKEOFF MINIMUMS AND (OBSTACLE) DEPARTURE PROCEDURES

AMDT 9 01FEB18 (18032) (FAA)

##### TAKEOFF MINIMUMS:

**Rwy 13**, std. w/ min. climb of 205' per NM to 1800 or 900-2½ for VCOA.

##### VCOA:

**Rwy 13**, obtain ATC approval for VCOA when requesting IFR clearance. Climb in visual conditions to cross Allegheny County Airport at or above 2000 before proceeding on course.

##### TAKEOFF OBSTACLE NOTES:

**Rwy 10**, vertical point 2' from DER, 75' right of centerline, 1' AGL/1251' MSL.

Tree 3525' from DER, 746' left of centerline, 85' AGL/1341' MSL.

Tree 3750' from DER, 578' left of centerline, 67' AGL/1350' MSL.

Tree 3786' from DER, 518' left of centerline, 72' AGL/1353' MSL.

**Rwy 13**, pole 175' from DER, 335' right of centerline, 26' AGL/1264' MSL.

Tree 362' from DER, 295' right of centerline, 53' AGL/1288' MSL.

Vertical point 460' from DER, 588' right of centerline, 60' AGL/1296' MSL.

Tree 912' from DER, 527' right of centerline, 73' AGL/1312' MSL.

**Rwy 31**, light 10' from DER, 87' right of centerline, 4' AGL/1246' MSL.

Poles beginning 264' from DER, 298' right of centerline, 38' AGL/1263' MSL.

## PITTSBURGH, PA

### PITTSBURGH INTL (PIT)

#### TAKEOFF MINIMUMS AND (OBSTACLE) DEPARTURE PROCEDURES

AMDT 5 15SEP16 (16259) (FAA)

##### TAKEOFF MINIMUMS:

**Rwy 10L**, 300-1¼ or std. w/min. climb of 215' per NM to 1400, or alternatively, with std. takeoff minimums and a normal 200' per NM climb gradient, takeoff must occur no later than 1400' prior to DER.

**Rwy 32**, 300-1¼ or std. w/ min. climb of 255' per NM to 1500.

##### TAKEOFF OBSTACLE NOTES:

**Rwy 10C**, pole 24' from DER, 300' left of centerline, 3' AGL/1140' MSL.

Tree 2605' from DER, 461' left of centerline, 1222' MSL.

Tree 3174' from DER, 747' left of centerline, 1255' MSL.

Trees beginning 3221' from DER, 911' left of centerline, up to 1263' MSL.

Trees beginning 4539' from DER, 1348' right of centerline, up to 52' AGL/1255' MSL.

Tree 4700' from DER, 1489' right of centerline, 50' AGL/1257' MSL.

Tree 4728' from DER, 1504' right of centerline, 1261' MSL.

Tree 4739' from DER, 1629' right of centerline, 68' AGL/1263' MSL.

Tree 4918' from DER, 1450' right of centerline, 69' AGL/1264' MSL.

Tree 4963' from DER, 1298' right of centerline, 77' AGL/1266' MSL.

Tree 4976' from DER, 1363' right of centerline, 74' AGL/1268' MSL.

**Rwy 10L**, vertical structures beginning 24' from DER, 5' right of centerline, up to 2' AGL/1175' MSL.

Vertical structures beginning 24' from DER, 4' left of centerline, up to 2' AGL/1175' MSL.

Aircraft on ramps beginning 199' from DER, 250' right of centerline, up to 64' AGL/1232' MSL.

Tree 1380' from DER, 724' left of centerline, 70' AGL/1229' MSL.

Trees beginning 1386' from DER, 672' left of centerline, up to 1233' MSL.

Tower 4175' from DER, 863' left of centerline, 112' AGL/1282' MSL.

Water tower 1.0 NM from DER, 1786' right of centerline, 200' AGL/1340' MSL.

**Rwy 10R**, vertical structures beginning 9' from DER, 40' right of centerline, up to 2' AGL/1123' MSL.

Vertical structures beginning 9' from DER, 40' left of centerline, up to 2' AGL/1124' MSL.

Street sign 55' from DER, 307' left of centerline, 3' AGL/1125' MSL.

Tree 415' from DER, 586' left of centerline, 10' AGL/1137' MSL.

Tree 2905' from DER, 673' left of centerline, 1200' MSL.

Trees beginning 4568' from DER, 1146' right of centerline, up to 1252' MSL.

Poles beginning 4587' from DER, 1124' left of centerline, up to 49' AGL/1241' MSL.

CON'T

# TAKEOFF MINIMUMS, (OBSTACLE) DEPARTURE PROCEDURES, AND DIVERSE VECTOR AREA (RADAR VECTORS)

23334

NE-4



# TAKEOFF MINIMUMS, (OBSTACLE) DEPARTURE PROCEDURES, AND DIVERSE VECTOR AREA (RADAR VECTORS)

23334

## PITTSBURGH, PA (CON'T)

### PITTSBURGH INTL (PIT) (CON'T)

**Rwy 10R (CON'T)**, trees beginning 4595' from DER, 151' right of centerline, up to 70' AGL/1255' MSL.

Trees beginning 5041' from DER, 101' right of centerline, up to 50' AGL/1257' MSL.

Tree 5069' from DER, 306' right of centerline, 1261' MSL.

Trees beginning 5080' from DER, 296' right of centerline, up to 68' AGL/1263' MSL.

Tree 5103' from DER, 35' left of centerline, 62' AGL/1251' MSL.

Tree 5259' from DER, 252' right of centerline, 69' AGL/1264' MSL.

Tree 5304' from DER, 101' right of centerline, 77' AGL/1266' MSL.

Tree 5317' from DER, 165' right of centerline, 74' AGL/1268' MSL.

**Rwy 28C**, poles beginning 123' from DER, 498' right of centerline, up to 41' AGL/1149' MSL.

Aircraft on taxiways beginning 267' from DER, 489' right of centerline, up to 64' AGL/1208' MSL.

**Rwy 28L**, tree 2' from DER, 497' left of centerline, 46' AGL/1137' MSL.

Tree 39' from DER, 497' left of centerline, 1144' MSL.

Tree 2271' from DER, 1109' left of centerline, 1223' MSL.

**Rwy 28R**, vertical structures beginning 9' from DER, 4' left of centerline, up to 1' AGL/1204' MSL.

Vertical structures beginning 9' from DER, on centerline, up to 1' AGL/1204' MSL.

Tree 21' from DER, 490' right of centerline, 19' AGL/1214' MSL.

Bush 71' from DER, 477' right of centerline, 1215' MSL.

Pole 643' from DER, 632' left of centerline, 25' AGL/1223' MSL.

Tree 1808' from DER, 912' right of centerline, 1273' MSL.

**Rwy 32**, vertical structures beginning 10' from DER, 54' right of centerline, up to 2' AGL/1149' MSL.

Vertical structures beginning 10' from DER, 55' left of centerline, up to 2' AGL/1149' MSL.

Tree 80' from DER, 376' left of centerline, 40' AGL/1151' MSL.

Pole 453' from DER, 515' right of centerline, 37' AGL/1173' MSL.

Aircraft on taxiway 1372' from DER, 8' right of centerline, 64' AGL/1214' MSL.

Aircraft on taxiways beginning 1612' from DER, 13' right of centerline, up to 64' AGL/1216' MSL.

Aircraft on taxiway 1989' from DER, 190' left of centerline, 64' AGL/1224' MSL.

Aircraft on taxiway and tree beginning 2166' from DER, 8' right of centerline, up to 64' AGL/1221' MSL.

Aircraft on taxiway 2213' from DER, 352' left of centerline, 64' AGL/1226' MSL.

Tree 2575' from DER, 1097' right of centerline, 70' AGL/1229' MSL.

Tree 2577' from DER, 1107' right of centerline, 1233' MSL.

Aircraft on taxiways beginning 2580' from DER, 425' left of centerline, up to 64' AGL/1233' MSL.

Aircraft on taxiway 2942' from DER, 836' left of centerline, 64' AGL/1235' MSL.

Tree 2943' from DER, 1213' right of centerline, 73' AGL/1247' MSL.

Trees beginning 5831' from DER, 1271' right of centerline, up to 83' AGL/1336' MSL.

Tower 1.1 NM from DER, 514' left of centerline, 95' AGL/1341' MSL.

Tower 1.1 NM from DER, 436' left of centerline, 106' AGL/1354' MSL.

Communication tower 1.1 NM from DER, 436' left of centerline, 102' AGL/1349' MSL.

## POINT PLEASANT, WV

### MASON COUNTY (312)

#### TAKEOFF MINIMUMS AND (OBSTACLE) DEPARTURE PROCEDURES

AMDT 4A 04FEB16 (16035) (FAA)

##### TAKEOFF MINIMUMS:

**Rwy 7**, 300-1½ or std. w/min. climb of 212' per NM to 900, or alternatively, with std. takeoff minimums and a normal 200' per NM climb gradient, takeoff must occur no later than 1500' prior to DER.

**Rwy 25**, 400-2½.

##### DEPARTURE PROCEDURE:

**Rwy 7**, climb heading 082° to 1500 before proceeding on course.

**Rwy 25**, climb heading 252° to 2000 before turning right.

##### TAKEOFF OBSTACLE NOTES:

**Rwy 7**, trees beginning 13' from DER, 242' left of centerline, up to 70' AGL/709' MSL.

Trees beginning 95' from DER, 179' right of centerline, up to 67' AGL/706' MSL.

Trees 1.3 NM from DER, 442' right of centerline, up to 53' AGL/832' MSL.

**Rwy 25**, trees beginning abeam DER, 255' left of centerline, up to 100' AGL/759' MSL.

Vehicles on road and trees beginning 292' from DER, 20' right of centerline, up to 100' AGL/739' MSL.

Trees 143' from DER, 490' left of centerline, up to 100' AGL/799' MSL.

Tower 2.1 NM from DER, 598' right of centerline, 155' AGL/964' MSL.

22 FEB 2024 to 21 MAR 2024

22 FEB 2024 to 21 MAR 2024

# TAKEOFF MINIMUMS, (OBSTACLE) DEPARTURE PROCEDURES, AND DIVERSE VECTOR AREA (RADAR VECTORS)

23334

NE-4

# TAKEOFF MINIMUMS, (OBSTACLE) DEPARTURE PROCEDURES, AND DIVERSE VECTOR AREA (RADAR VECTORS)

23334

## POTTSTOWN, PA

### HERITAGE FLD (PTW)

#### TAKEOFF MINIMUMS AND (OBSTACLE) DEPARTURE PROCEDURES

AMDT 2B 06DEC18 (21280) (FAA)

#### TAKEOFF MINIMUMS:

**Rwy 10**, 300-1¼ or std. w/min. climb of 290' per NM to 600.

**Rwy 28**, 500-2.

#### DEPARTURE PROCEDURE:

**Rwy 28**, climb heading 276° to 900 before proceeding on course.

#### TAKEOFF OBSTACLE NOTES:

**Rwy 10**, tree, pole beginning 58' from DER, 18' right of centerline, up to 365' MSL.

Building, tree beginning 403' from DER, 136' left of centerline, up to 25' AGL/339' MSL.

Tree, building beginning 745' from DER, 23' left of centerline, up to 380' MSL.

Tree 1573' from DER, 111' right of centerline, 376' MSL.

Tree 1620' from DER, 248' right of centerline, 379' MSL.

Tree 1701' from DER, 136' right of centerline, 384' MSL.

Tree 2004' from DER, 239' right of centerline, 388' MSL.

Tree 2127' from DER, 11' right of centerline, 398' MSL.

Trees beginning 2198' from DER, 71' left of centerline, up to 410' MSL.

Tree, building beginning 2414' from DER, 19' left of centerline, up to 416' MSL.

Tree, building beginning 2486' from DER, 22' right of centerline, up to 425' MSL.

Tank, water tower beginning 1 NM from DER, 349' right of centerline, up to 111' AGL/477' MSL.

**Rwy 28**, tree 124' from DER, 481' right of centerline, 327' MSL.

Trees beginning 845' from DER, 12' right of centerline, up to 337' MSL.

Trees 910' from DER, 107' left of centerline, 332' MSL.

Trees beginning 1007' from DER, 61' right of centerline, up to 338' MSL.

Trees beginning 1138' from DER, 53' right of centerline, up to 372' MSL.

Tower 1.3 NM from DER, 1680' left of centerline, 295' AGL/544' MSL.

## POTTSTOWN MUNI (N47)

#### TAKEOFF MINIMUMS AND (OBSTACLE) DEPARTURE PROCEDURES

AMDT 2B 21JUN18 (18172) (FAA)

#### TAKEOFF MINIMUMS:

**Rwy 8**, 600-3 w/min. climb of 241' per NM to 1300, or 1300-2½ for climb in visual conditions.

**Rwy 26**, std. w/min. climb of 288' per NM to 1600, or 1300-2½ for climb in visual conditions.

#### DEPARTURE PROCEDURE:

**Rwy 8**, climb heading 076° to 1300 before proceeding on course. For climb in visual conditions: cross Pottstown Muni Airport at or above 1400 MSL before proceeding on course.

**Rwy 26**, climb heading 271° to 1100 before proceeding on course. For climb in visual conditions: cross Pottstown Muni Airport at or above 1400 MSL before proceeding on course.

#### TAKEOFF OBSTACLE NOTES:

**Rwy 8**, terrain 2761' from DER, 124' right of centerline, 0' AGL/319' MSL.

Multiple trees beginning 5919' from DER, 854' left of centerline, up to 100' AGL/559' MSL.

Multiple trees beginning 1.3 NM from DER, 616' right of centerline, up to 100' AGL/759' MSL.

**Rwy 26**, tree 400' from DER, on centerline, 35' AGL/295' MSL.

Terrain 10' from DER, 246' left of centerline, 0' AGL/279' MSL.

Tree 399' from DER, on centerline, up to 100' AGL/295' MSL.

Multiple trees beginning 1 NM from DER, 2009' right of centerline, up to 100' AGL/579' MSL.

## POTTSTOWN, PA

### SCHUYLKILL COUNTY/JOE ZERBEY (ZER)

#### TAKEOFF MINIMUMS AND (OBSTACLE) DEPARTURE PROCEDURES

AMDT 3 31DEC20 (20366) (FAA)

#### TAKEOFF MINIMUMS:

**Rwys 4, 22**, NA - Environmental.

#### TAKEOFF OBSTACLE NOTES:

**Rwy 11**, terrain 11' from DER, 5' right of centerline, 1707' MSL.

Lighting 17' from DER, 112' left of centerline, 5' AGL/1709' MSL.

Lighting 18' from DER, 111' right of centerline, 6' AGL/1708' MSL.

Trees beginning 56' from DER, 322' right of centerline, up to 37' AGL/1716' MSL.

Trees beginning 77' from DER, 278' left of centerline, up to 28' AGL/1723' MSL.

Tree 155' from DER, 356' right of centerline, 42' AGL/1718' MSL.

Tree 267' from DER, 474' left of centerline, 45' AGL/1725' MSL.

**Rwy 29**, lighting 9' from DER, 16' right of centerline, 12' AGL/1731' MSL.

Lighting 10' from DER, 28' left of centerline, 12' AGL/1731' MSL.

Tree 30' from DER, 402' left of centerline, 33' AGL/1740' MSL.

Trees beginning 122' from DER, 258' left of centerline, up to 23' AGL/1742' MSL.

Trees beginning 162' from DER, 349' right of centerline, up to 35' AGL/1745' MSL.

Tree 373' from DER, 520' left of centerline, 37' AGL/1751' MSL.

Tree 510' from DER, 515' left of centerline, 40' AGL/1756' MSL.

# TAKEOFF MINIMUMS, (OBSTACLE) DEPARTURE PROCEDURES, AND DIVERSE VECTOR AREA (RADAR VECTORS)

23334

NE-4

# TAKEOFF MINIMUMS, (OBSTACLE) DEPARTURE PROCEDURES, AND DIVERSE VECTOR AREA (RADAR VECTORS)

23334

## PUNXSUTAWNEY, PA

### PUNXSUTAWNEY MUNI (N35)

#### TAKEOFF MINIMUMS AND (OBSTACLE) DEPARTURE PROCEDURES

AMDT 3A 30NOV23 (23334) (FAA)

##### TAKEOFF MINIMUMS:

**Rwys 1, 19**, NA-Environmental.

**Rwy 6**, 400-2½ or std w/min climb of 344'/NM to 2000.

##### DEPARTURE PROCEDURE:

**Rwy 6**, climb on heading 067° to 2000 before proceeding on course.

**Rwy 24**, climb on heading 247° to 2300 before proceeding on course.

##### TAKEOFF OBSTACLE NOTES:

**Rwy 6**, aircraft on taxiway 4' from DER, 171' right of centerline, up to 10' AGL/1447' MSL.

Trees beginning 285' from DER, 304' left of centerline, up to 100' AGL/1542' MSL.

Vehicle on road 505' from DER, 304' left of centerline, up to 15' AGL/1457' MSL.

Building 732' from DER, 685' right of centerline, up to 40' AGL/1480' MSL.

Vehicle on road 733' from DER, 352' right of centerline, up to 15' AGL/1457' MSL.

Trees beginning 1252' from DER, 417' right of centerline, up to 100' AGL/1499' MSL.

**Rwy 24**, buildings beginning 192' from DER, 57' right of centerline, up to 30' AGL/1489' MSL.

Trees beginning 232' from DER, 174' left of centerline, up to 100' AGL/1510' MSL.

Trees beginning 1015' from DER, 310' right of centerline, up to 100' AGL/1559' MSL.

## QUAKERTOWN, PA

### QUAKERTOWN (UKT)

#### TAKEOFF MINIMUMS AND (OBSTACLE) DEPARTURE PROCEDURES

AMDT 1 28JUN12 (12180) (FAA)

##### TAKEOFF MINIMUMS:

**Rwy 29**, 300-1 or std. w/min. climb of 730' per NM to 800.

##### TAKEOFF OBSTACLE NOTES:

**Rwy 11**, multiple trees, structures and poles beginning 19' from DER, 1300' left of centerline to 1385' right of centerline, up to 100' AGL/639' MSL.

**Rwy 29**, multiple trees, structures and poles beginning 27' from DER, 1329' left of centerline to 1049' right of centerline, up to 100' AGL/691' MSL.

## RAVENSWOOD, WV

### JACKSON COUNTY (I18)

#### TAKEOFF MINIMUMS AND (OBSTACLE) DEPARTURE PROCEDURES

AMDT 2 25AUG11 (11237) (FAA)

##### TAKEOFF MINIMUMS:

**Rwy 4**, 300-2 or std. w/min. climb of 225' per NM to 1200.

##### DEPARTURE PROCEDURE:

**Rwy 4**, climb heading 037° to 1300 before turning west.

**Rwy 22**, climb heading 217° to 1300 before turning north.

##### TAKEOFF OBSTACLE NOTES:

**Rwy 4**, trees beginning 2137' from DER, 539' right of centerline, up to 100' AGL/890' MSL.

Trees beginning 1.6 NM from DER, 517' left of centerline, up to 100' AGL/1019' MSL.

**Rwy 22**, trees beginning 6' from DER, 476' right of centerline up to 100' AGL/802' MSL.

Trees beginning 2528' from DER 774' left of centerline, up to 100' AGL/879' MSL.

22 FEB 2024 to 21 MAR 2024

22 FEB 2024 to 21 MAR 2024

# TAKEOFF MINIMUMS, (OBSTACLE) DEPARTURE PROCEDURES, AND DIVERSE VECTOR AREA (RADAR VECTORS)

23334

NE-4

# TAKEOFF MINIMUMS, (OBSTACLE) DEPARTURE PROCEDURES, AND DIVERSE VECTOR AREA (RADAR VECTORS)

23334

## READING, PA

READING RGNL/CARL A SPAATZ FLD (RDG)

TAKEOFF MINIMUMS AND (OBSTACLE) DEPARTURE PROCEDURES

AMDT 5A 19JUL18 (21112) (FAA)

TAKEOFF MINIMUMS:

**Rwy 13**, std. w/min. climb of 445' per NM to 1700.

**Rwy 31**, 500-2 $\frac{1}{2}$  or std. w/min. climb of 430' per NM to 900.

**Rwy 36**, 400-2 or std. w/min. climb of 360' per NM to 510.

DEPARTURE PROCEDURE:

**Rwy 18**, climb heading 184 $\frac{1}{2}$  to 1400 before turning left.

**Rwy 31**, climb heading 313 $\frac{1}{2}$  to 900 before turning right.

**Rwy 36**, climb heading 004 $\frac{1}{2}$  to 1100 before turning right

TAKEOFF OBSTACLE NOTES:

**Rwy 13**, NAVAID 9' from DER, 54' left of centerline, 1' AGL/330' MSL.

Pole 67' from DER, 413' right of centerline, 23' AGL/354' MSL.

Tower 96' from DER, 476' right of centerline, 40' AGL/372' MSL.

Antenna, building beginning 96' from DER, 377' right of centerline, up to 41' AGL/373' MSL.

Trees beginning 871' from DER, 512' right of centerline, up to 378' MSL.

Tree 1690' from DER, 282' left of centerline, 376' MSL.

Tree 2521' from DER, 330' left of centerline, 398' MSL.

**Rwy 18**, NAVAID 8' from DER, 54' left of centerline, 1' AGL/343' MSL.

Building 61' from DER, 488' right of centerline, 6' AGL/352' MSL.

Tree 915' from DER, 663' left of centerline, 385' MSL.

**Rwy 31**, NAVAID 10' from DER, 55' right of centerline, 1' AGL/344' MSL.

Trees beginning 5385' from DER, 1761' right of centerline, up to 518' MSL.

Tree, pole beginning 5671' from DER, 1937' right of centerline, up to 548' MSL.

Tree, pole beginning 6045' from DER, 1640' right of centerline, up to 568' MSL.

Trees beginning 1 NM from DER, 1224' right of centerline, up to 582' MSL.

Trees beginning 1 NM from DER, 1273' right of centerline, up to 655' MSL.

Tree 1.1 NM from DER, 1972' right of centerline, 666' MSL.

Tree, terrain, electrical system, windmill beginning 1.1 NM from DER, 465' right of centerline, up to 702' MSL.

Trees beginning 1.8 NM from DER, 1753' right of centerline, up to 709' MSL.

Tree 1.8 NM from DER, 2179' right of centerline, 727' MSL.

Tree, building beginning 1.8 NM from DER, 1645' right of centerline, up to 752' MSL.

Trees beginning 1.9 NM from DER, 887' right of centerline, up to 776' MSL.

**Rwy 36**, NAVAID 10' from DER, 54' left of centerline, 1' AGL/292' MSL.

NAVAID, terrain beginning 10' from DER, 55' right of centerline, up to 2' AGL/292' MSL.

Terrain 57' from DER, 55' right of centerline, 299' MSL.

Terrain beginning 89' from DER, 174' left of centerline, up to 306' MSL.

Trees beginning 485' from DER, 210' left of centerline, up to 341' MSL.

Trees beginning 734' from DER, 682' right of centerline, up to 338' MSL.

Tree 908' from DER, 601' right of centerline, 345' MSL.

Trees beginning 1049' from DER, 0' of centerline, up to 346' MSL.

Trees beginning 1385' from DER, 269' left of centerline, up to 355' MSL.

Trees beginning 1497' from DER, 124' left of centerline, up to 357' MSL.

Tree 2543' from DER, 336' right of centerline, 356' MSL.

Tree 2581' from DER, 165' right of centerline, 358' MSL.

Tree 3410' from DER, 96' left of centerline, 382' MSL.

Trees beginning 3555' from DER, 161' right of centerline, up to 450' MSL.

Tree 1.3 NM from DER, 2599' left of centerline, 537' MSL.

Tree 1.4 NM from DER, 2528' left of centerline, 575' MSL.

Trees beginning 1.4 NM from DER, 2402' left of centerline, up to 603' MSL.

Tree 1.4 NM from DER, 2508' left of centerline, 613' MSL.

Trees beginning 1.4 NM from DER, 2042' left of centerline, up to 631' MSL.

Trees beginning 1.5 NM from DER, 1982' left of centerline, up to 672' MSL.

Tree 1.5 NM from DER, 2193' left of centerline, 545' MSL.

22 FEB 2024 to 21 MAR 2024

22 FEB 2024 to 21 MAR 2024

# TAKEOFF MINIMUMS, (OBSTACLE) DEPARTURE PROCEDURES, AND DIVERSE VECTOR AREA (RADAR VECTORS)

23334

# TAKEOFF MINIMUMS, (OBSTACLE) DEPARTURE PROCEDURES, AND DIVERSE VECTOR AREA (RADAR VECTORS)

23334

## REEDSVILLE, PA

### MIFFLIN COUNTY (RVL)

#### TAKEOFF MINIMUMS AND (OBSTACLE) DEPARTURE PROCEDURES

AMDT 3 05JUN08 (08157) (FAA)

##### TAKEOFF MINIMUMS:

**Rwy 6**, std. w/ min. climb of 287' per NM to 3000 or 2200-3 for climb in visual conditions.

**Rwy 24**, std. w/ min. climb of 242' per NM to 2800 or 2200-3 for climb in visual conditions.

##### DEPARTURE PROCEDURE:

**Rwy 6**, climb heading 059° to 3000 before proceeding on course or for climb in visual conditions cross Mifflin County Airport at or above 3000 MSL before proceeding on course.

**Rwy 24**, climb heading 239° to 2800 before proceeding on course or for climb in visual conditions cross Mifflin County Airport at or above 3000 MSL before proceeding on course.

##### TAKEOFF OBSTACLE NOTES:

**Rwy 6**, fence beginning 59' from DER, 497' right of centerline, up to 6' AGL/825' MSL.

Bushes 449' from DER, 422' right of centerline, up to 10' AGL/829' MSL.

**Rwy 24**, ground 171' from DER, 481' left of centerline, 0' AGL/830' MSL.

Fence 207' from DER, 288' left of centerline, 15' AGL/834' MSL.

Trees 1189' from DER, 198' right of centerline, up to 100' AGL/933' MSL.

Trees 2,168' from DER, 407' left of centerline, up to 100' AGL/908' MSL.

## ST. MARYS, PA

### ST MARYS MUNI (OYM)

#### TAKEOFF MINIMUMS AND (OBSTACLE) DEPARTURE PROCEDURES

AMDT 2A 13SEP18 (18256) (FAA)

##### TAKEOFF MINIMUMS:

**Rwy 10**, std. w/min. climb of 230' per NM to 2800, or 1000-3 for VCOA.

##### VCOA:

**Rwy 10**, obtain ATC approval for VCOA when requesting IFR clearance. Climb in visual conditions to cross St Marys Muni airport at or above 2800 before proceeding on course.

##### TAKEOFF OBSTACLE NOTES:

**Rwy 10**, vehicles on road, terrain beginning 197' from DER, 275' left of centerline, up to 1952' MSL.

Pole, tree beginning 410' from DER, 211' right of centerline, up to 37' AGL/1963' MSL.

Pole, building beginning 690' from DER, 411' left of centerline, up to 36' AGL/1978' MSL.

Tree 1023' from DER, 680' right of centerline, 1987' MSL.

Tree 1280' from DER, 723' right of centerline, 102' AGL/2030' MSL.

Tree 1984' from DER, 728' right of centerline, 2045' MSL.

Tree 2238' from DER, 303' left of centerline, 67' AGL/2006' MSL.

Trees beginning 2452' from DER, 62' right of centerline, up to 91' AGL/2056' MSL.

Trees beginning 2475' from DER, 686' left of centerline, up to 98' AGL/2027' MSL.

**Rwy 28**, trees beginning 12' from DER, 213' right of centerline, up to 1948' MSL.

Pole 91' from DER, 263' left of centerline, 23' AGL/1928' MSL.

Tree, NAVAJD beginning 466' from DER, on centerline, up to 1967' MSL.

Pole, NAVAJD, tree beginning 544' from DER, 255' left of centerline, up to 33' AGL/1954' MSL.

Tree 659' from DER, 451' right of centerline, 75' AGL/1968' MSL.

Tree 2194' from DER, 25' left of centerline, 73' AGL/1965' MSL.

## SELINGSGROVE, PA

### PENN VALLEY (SEG)

#### TAKEOFF MINIMUMS AND (OBSTACLE) DEPARTURE PROCEDURES

AMDT 3A 01FEB18 (18032) (FAA)

##### TAKEOFF MINIMUMS:

**Rwy 17**, std. w/ min. climb of 500' per NM to 1500 or 1500-2½ for VCOA.

**Rwy 35**, 500-2 w/ min. climb of 500' per NM to 1300 or 1500-2½ for VCOA.

##### DEPARTURE PROCEDURE:

**Rwy 17**, climbing right turn direct SEG VOR/DME before proceeding on course. Do not exceed 180K until SEG VOR/DME.

**Rwy 35**, climb heading 350° to 1900 before proceeding on course.

VCOA: All runways, obtain ATC approval for VCOA when requesting IFR clearance. Climb in visual conditions to cross Penn Valley Airport at or above 1800 before proceeding on course.

##### TAKEOFF OBSTACLE NOTES:

**Rwy 17**, trees beginning 1.8 NM from DER, 1068' left of centerline, up to 100' AGL/919' MSL.

Trees beginning 29' from DER, 151' left of centerline, up to 100' AGL/559' MSL.

Pole 2520' from DER, 84' right of centerline, 58' AGL/508' MSL.

**Rwy 35**, trees beginning 273' from DER, 75' left of centerline, up to 100' AGL/539' MSL.

Trees beginning 1947' from DER, 624' right of centerline, up to 100' AGL/899' MSL.

# TAKEOFF MINIMUMS, (OBSTACLE) DEPARTURE PROCEDURES, AND DIVERSE VECTOR AREA (RADAR VECTORS)

23334

NE-4

22 FEB 2024 to 21 MAR 2024

22 FEB 2024 to 21 MAR 2024

# TAKEOFF MINIMUMS, (OBSTACLE) DEPARTURE PROCEDURES, AND DIVERSE VECTOR AREA (RADAR VECTORS)

23334

## SHAMOKIN, PA

NORTHUMBERLAND COUNTY (N79)

TAKEOFF MINIMUMS AND (OBSTACLE) DEPARTURE PROCEDURES

AMDT 2A 01FEB18 (18032) (FAA)

TAKEOFF MINIMUMS:

**Rwy 8**, 400-2 or std. w/ min. climb of 540' per NM to 1600.**Rwy 26**, 400-2½ or std. w/ min. climb of 270' per NM to 1400.

DEPARTURE PROCEDURE:

**Rwy 8**, climb to 1600 then climbing left turn to 4000 direct SEG VOR/DME.**Rwy 26**, climb to 1400 then climb to 4000 on SEG R-088 to SEG VOR/DME.

TAKEOFF OBSTACLE NOTES:

**Rwy 8**, trees beginning 33' from DER, 366' left of centerline, up to 70' AGL/950' MSL.

Pole 68' from DER, 459' right of centerline, 39' AGL/910' MSL.

Vehicles on roadway beginning 279' from DER, left and right of centerline, up to 15' AGL/952' MSL.

Trees beginning 1548' from DER, 197' left of centerline, up to 80' AGL/1171' MSL.

Buildings beginning 2631' from DER, 870' left of centerline, up to 38' AGL/1164' MSL.

Fence beginning 5683' from DER, 1796' left of centerline, up to 6' AGL/1099' MSL.

Pole 1.1 NM from DER, 1662' left of centerline, 23' AGL/1091' MSL.

**Rwy 26**, trees beginning 10' from DER, 242' left of centerline, up to 13' AGL/865' MSL.

Trees beginning 84' from DER, 184' right of centerline, up to 20' AGL/872' MSL.

Trees beginning 2.1 NM from DER, 2621' right of centerline, up to 80' AGL/1240' MSL.

## SOMERSET, PA

SOMERSET COUNTY (2G9)

TAKEOFF MINIMUMS AND (OBSTACLE) DEPARTURE PROCEDURES

AMDT 2 20DEC07 (07354) (FAA)

TAKEOFF MINIMUMS:

**Rwys 14, 32**, NA-Environmental.

DEPARTURE PROCEDURE:

**Rwy 7**, climb heading 066° to 3000 before turning south.**Rwy 25**, climb heading 246° to 2800 before turning south.

TAKEOFF OBSTACLE NOTES:

**Rwy 7**, trees beginning 57' from DER, 178' right of centerline, up to 79' AGL/2285' MSL.

Tree 1291' from DER, 76' left of centerline, 59' AGL/2238' MSL.

Buildings beginning 639' from DER, 348' left of centerline, up to 40' AGL/2222' MSL.

**Rwy 25**, trees beginning 480' from DER, 152' right of centerline, up to 67' AGL/2346' MSL.

Antenna on building 283' from DER, 204' right of centerline, 30' AGL/2290' MSL.

Tree 584' from DER, 211' left of centerline, 55' AGL/2297' MSL.

Obstruction light on localizer 291' from DER, on centerline, 20' AGL/2284' MSL.

## SPENCER, WV

BOGGS FLD (USW)

TAKEOFF MINIMUMS AND (OBSTACLE) DEPARTURE PROCEDURES

AMDT 1 20SEP12 (22083) (FAA)

TAKEOFF MINIMUMS:

**Rwy 10**, 300-2 or std. w/min. climb of 447' per NM to 1300.**Rwy 28**, 400-2½ or std. w/min. climb of 332' per NM to 1400.

DEPARTURE PROCEDURE:

**Rwy 10**, climb heading 100° to 1400 before proceeding on course.**Rwy 28**, climb heading 280° to 1600 before turning south.

TAKEOFF OBSTACLE NOTES:

**Rwy 10**, vegetation beginning 14' from DER, left and right of centerline, up to 13' AGL/932' MSL.

Terrain and trees beginning 2060' from DER, 3' right of centerline, up to 60' AGL/1079' MSL.

Terrain, trees and buildings beginning 3169' from DER, 14' left of centerline, up to 60' AGL/1079' MSL.

Tree 4288' from DER, 236' right of centerline, up to 88' AGL/1167' MSL.

Tree 1.2 NM from DER, 1867' left of centerline, up to 35' AGL/1194' MSL.

Tree 1.7 NM from DER, 1510' right of centerline, up to 63' AGL/1182' MSL.

**Rwy 28**, terrain, trees, fences and pole beginning 13' from DER, 17' right of centerline, up to 74' AGL/1073' MSL.

Trees beginning 764' from DER, 14' left of centerline, up to 76' AGL/1055' MSL.

Tree 3587' from DER, 1432' right of centerline, up to 82' AGL/1081' MSL.

Tree 1.8 NM from DER, 3390' left of centerline, up to 63' AGL/1242' MSL.

Tree 2 NM from DER, 3063' left of centerline, up to 63' AGL/1252' MSL.

22 FEB 2024 to 21 MAR 2024

22 FEB 2024 to 21 MAR 2024

# TAKEOFF MINIMUMS, (OBSTACLE) DEPARTURE PROCEDURES, AND DIVERSE VECTOR AREA (RADAR VECTORS)

23334

NE-4

# TAKEOFF MINIMUMS, (OBSTACLE) DEPARTURE PROCEDURES, AND DIVERSE VECTOR AREA (RADAR VECTORS)

23334

## STATE COLLEGE, PA

STATE COLLEGE RGNL (UNV)

TAKEOFF MINIMUMS AND (OBSTACLE) DEPARTURE PROCEDURES

AMDT 4 05NOV98 (23278) (FAA)

TAKEOFF MINIMUMS:

**Rwys 16, 34, NA.**

DEPARTURE PROCEDURE:

**Rwys 6, 24,** climb runway heading to 2600 before proceeding on course.

## SUMMERSVILLE, WV

SUMMERSVILLE (SXL)

TAKEOFF MINIMUMS AND (OBSTACLE) DEPARTURE PROCEDURES

AMDT 3B 13SEP18 (18256) (FAA)

TAKEOFF MINIMUMS:

**Rwy 4,** 400-1 or std. w/min. climb of 350' per NM to 3000.

DEPARTURE PROCEDURE:

**Rwy 4,** climb heading 044° to 2900 before proceeding on course.**Rwy 22,** climb heading 224° to 2400 before proceeding on course.

TAKEOFF OBSTACLE NOTES:

**Rwy 22,** multiple trees beginning 139' from DER, 185' right of centerline, up to 98' AGL/1877' MSL.

Tree 223' from DER, 154' left of centerline, 93' AGL/1835' MSL.

## SUTTON, WV

BRAXTON COUNTY (481)

TAKEOFF MINIMUMS AND (OBSTACLE) DEPARTURE PROCEDURES

AMDT 1 21JUL16 (22279) (FAA)

TAKEOFF MINIMUMS:

**Rwy 2,** 300-1.**Rwy 20,** 500-2½ w/min. climb of 290' per NM to 2400 or 1200-3 for climb in visual conditions.

DEPARTURE PROCEDURE:

**Rwy 2,** climb via heading 016° to 2200 before turning left.

VCOA:

**Rwy 20,** obtain ATC approval for climb in visual conditions when requesting IFR clearance. Climb in visual conditions to cross Sutton County airport at or above 2300 before proceeding on course.

TAKEOFF OBSTACLE NOTES:

**Rwy 2,** terrain, fences, and vehicles on road beginning 61' from DER, 90' right of centerline, up to 15' AGL/1311' MSL.

Terrain, fences, and vehicles on road beginning 77' from DER, 48' left of centerline, up to 15' AGL/1307' MSL.

Pole and trees beginning 56' from DER, 298' right of centerline, up to 90' AGL/1409' MSL.

Trees beginning 22' from DER, 244' left of centerline, up to 78' AGL/1417' MSL.

Terrain and trees beginning 556' from DER, 223' left of centerline, up to 80' AGL/1399' MSL.

Trees beginning 1015' from DER, 260' right of centerline, up to 106' AGL/1435' MSL.

Trees beginning 889' from DER, 233' left of centerline, up to 116' AGL/1445' MSL.

Trees 4508' from DER, 1011' left of centerline, up to 65' AGL/1484' MSL.

**Rwy 20,** fences, vehicles on road, poles, and trees beginning 197' from DER, 40' left of centerline, up to 49' AGL/1337' MSL.

Trees beginning 468' from DER, 1' right of centerline, up to 45' AGL/1324' MSL.

Terrain and trees beginning 72' from DER, 264' left of centerline, up to 76' AGL/1435' MSL.

Trees beginning 26' from DER, 311' right of centerline, up to 97' AGL/1376' MSL.

Trees beginning 1123' from DER, 54' right of centerline, up to 96' AGL/1515' MSL.

Trees beginning 4425' from DER, 47' left of centerline, up to 93' AGL/1529' MSL.

Trees beginning 1.5 NM from DER, left and right of centerline, up to 111' AGL/1590' MSL.

Trees 2.4 NM from DER, 3786' left of centerline, up to 100' AGL/1739' MSL.

22 FEB 2024 to 21 MAR 2024

22 FEB 2024 to 21 MAR 2024

# TAKEOFF MINIMUMS, (OBSTACLE) DEPARTURE PROCEDURES, AND DIVERSE VECTOR AREA (RADAR VECTORS)

23334

NE-4

# TAKEOFF MINIMUMS, (OBSTACLE) DEPARTURE PROCEDURES, AND DIVERSE VECTOR AREA (RADAR VECTORS)

23334

## TITUSVILLE, PA

### TITUSVILLE (6G1)

#### TAKEOFF MINIMUMS AND (OBSTACLE) DEPARTURE PROCEDURES

ORIG-A 08SEP22 (22251) (FAA)

#### TAKEOFF OBSTACLE NOTES:

**Rwy 1**, trees, vehicles on road beginning 21' from DER, 31' left of centerline, up to 1657' MSL.  
Vehicle on road 64' from DER, 40' right of centerline, 1616' MSL.  
Vehicle on road 76' from DER, 152' right of centerline, 1618' MSL.  
Building, vehicle on road beginning 97' from DER, 263' right of centerline, up to 21' AGL/1625' MSL.  
Buildings beginning 156' from DER, 469' right of centerline, up to 29' AGL/1632' MSL.  
Trees, pole beginning 385' from DER, 201' left of centerline, up to 1663' MSL.  
Tree 983' from DER, 273' right of centerline, 1633' MSL.  
Tree 1041' from DER, 565' right of centerline, 1642' MSL.  
Tree 1990' from DER, 212' left of centerline, 1666' MSL.  
Trees beginning 2013' from DER, 561' left of centerline, up to 1674' MSL.  
Trees beginning 2333' from DER, 195' left of centerline, up to 1676' MSL.  
Trees beginning 2556' from DER, 185' left of centerline, up to 1679' MSL.  
Tree 2743' from DER, 77' right of centerline, 1672' MSL.  
Trees beginning 2769' from DER, 97' right of centerline, up to 1685' MSL.  
Trees beginning 2792' from DER, 65' left of centerline, up to 1697' MSL.  
Trees beginning 3231' from DER, 388' left of centerline, up to 1700' MSL.  
Trees beginning 3361' from DER, 250' left of centerline, up to 1705' MSL.  
Tree 3686' from DER, 778' left of centerline, 1706' MSL.  
Trees beginning 3688' from DER, 266' left of centerline, up to 1713' MSL.  
Tree 3917' from DER, 847' left of centerline, 1714' MSL.  
Trees beginning 3944' from DER, 747' left of centerline, up to 1728' MSL.  
**Rwy 19**, sign 14' from DER, 142' left of centerline, 4' AGL/1534' MSL.  
Terrain 38' from DER, 217' right of centerline, 1536' MSL.  
Fence 160' from DER, 495' right of centerline, 17' AGL/1543' MSL.  
Fence 167' from DER, 368' right of centerline, 16' AGL/1545' MSL.  
Fence 197' from DER, 217' right of centerline, 13' AGL/1546' MSL.  
Tree, fence beginning 355' from DER, 230' right of centerline, up to 1572' MSL.  
Trees beginning 508' from DER, 202' right of centerline, up to 1598' MSL.  
Trees beginning 938' from DER, 183' left of centerline, up to 1579' MSL.  
Trees beginning 950' from DER, 457' right of centerline, up to 1612' MSL.  
Trees beginning 1195' from DER, 251' left of centerline, up to 1587' MSL

## TOUGHKENAMON, PA

### NEW GARDEN (N57)

#### TAKEOFF MINIMUMS AND (OBSTACLE) DEPARTURE PROCEDURES

AMDT 1A 08SEP22 (22251) (FAA)

#### TAKEOFF MINIMUMS:

**Rwy 6**, 300-1.

#### DEPARTURE PROCEDURE:

**Rwy 6**, climb on heading 055° to 900 before proceeding on course.  
**Rwy 24**, climb on heading 235° to 900 before proceeding on course.

#### TAKEOFF OBSTACLE NOTES:

**Rwy 6**, tree 4' from DER, 162' right of centerline, 16' AGL/433' MSL.  
Tree, building, pole beginning 185' from DER, 91' left of centerline, up to 92' AGL/521' MSL.  
Tree, pole, tower, building, tank beginning 953' from DER, 58' right of centerline, up to 110' AGL/569' MSL.  
**Rwy 24**, pole 8' from DER, 10' right of centerline, 2' AGL/435' MSL.  
Pole 9' from DER, 10' left of centerline, 2' AGL/435' MSL.  
Tree 26' from DER, 198' right of centerline, 49' AGL/471' MSL.  
Trees beginning 31' from DER, 171' left of centerline, up to 92' AGL/448' MSL.  
Tree 189' from DER, 250' right of centerline, 64' AGL/482' MSL.  
Tree 291' from DER, 427' right of centerline, 106' AGL/489' MSL.  
Trees beginning 361' from DER, 385' right of centerline, up to 109' AGL/493' MSL.

## TOWANDA, PA

### BRADFORD COUNTY (N27)

#### TAKEOFF MINIMUMS AND (OBSTACLE) DEPARTURE PROCEDURES

AMDT 2A 11OCT18 (18284) (FAA)

#### TAKEOFF MINIMUMS:

**Rwy 5**, 800-3 w/min. climb of 333' per NM to 2000, or std. w/min. climb of 461' per NM to 2000, or 2000-3 for VCOA.  
**Rwy 23**, std. w/min. climb of 685' per NM to 2800, or 2000-3 for VCOA.

#### DEPARTURE PROCEDURE:

**Rwy 5**, climb heading 047° to 2000 before proceeding on course or for climb in visual conditions: cross Bradford County airport at or above 2600 before proceeding on course. When executing VCOA, notify ATC prior to departure.  
**Rwy 23**, climb heading 227° to 2000 before proceeding on course or for climb in visual conditions: cross Bradford County airport at or above 2600 before proceeding on course. When executing VCOA, notify ATC prior to departure.

#### TAKEOFF OBSTACLE NOTES:

**Rwy 5**, pole and trees beginning 4' from DER, 267' right of centerline, up to 100' AGL/859' MSL.  
Grain bin/silo and trees beginning 131' from DER, 475' left of centerline, up to 100' AGL/823' MSL.  
CONT

# TAKEOFF MINIMUMS, (OBSTACLE) DEPARTURE PROCEDURES, AND DIVERSE VECTOR AREA (RADAR VECTORS)

23334

NE-4



# TAKEOFF MINIMUMS, (OBSTACLE) DEPARTURE PROCEDURES, AND DIVERSE VECTOR AREA (RADAR VECTORS)

23334

## TOWANDA, PA (CON'T)

### BRADFORD COUNTY (N27) (CON'T)

**Rwy 23**, trees beginning 1069' from DER, 1' left of centerline, up to 100' AGL/1159' MSL.

Navaid 14' from DER, 113' right of centerline, 12' AGL/731' MSL.

Trees beginning 3206' from DER, 44' right of centerline, up to 100' AGL/1287' MSL.

## TOWER CITY, PA

### BENDIGO (74N)

#### TAKEOFF MINIMUMS AND (OBSTACLE) DEPARTURE PROCEDURES

ORIG 02JUL09 (09183) (FAA)

##### TAKEOFF MINIMUMS:

**Rwy 5**, std. w/min. climb of 518' per NM to 2200 or 1700-2 for climb in visual conditions.

**Rwy 23**, NA-Terrain.

##### DEPARTURE PROCEDURE:

**Rwy 5**, departure NA at night. Climb heading 054° to 2200 before proceeding on course or for climb in visual conditions: cross Bendigo airport at or above 2300 before proceeding on course. Do not exceed 180 KIAS until crossing Bendigo airport on course.

##### TAKEOFF OBSTACLE NOTES:

**Rwy 5**, multiple trees beginning 330' from DER, 45' left of centerline, up to 100' AGL/919' MSL.

Multiple trees beginning 355' from DER, 81' right of centerline, up to 100' AGL/879' MSL.

Multiple towers beginning 2.1 NM from DER, 2384' left of centerline, up to 200' AGL/1559' MSL.

## WASHINGTON, PA

### WASHINGTON COUNTY (AFJ)

#### TAKEOFF MINIMUMS AND (OBSTACLE) DEPARTURE PROCEDURES

AMDT 4 10JAN13 (13010) (FAA)

##### TAKEOFF MINIMUMS:

**Rwy 9**, 600-2½ or std. w/min. climb of 397' per NM to 1900.

**Rwy 27**, 300-1¾ or std. w/min. climb of 932' per NM to 1500.

##### TAKEOFF OBSTACLE NOTES:

**Rwy 9**, trees beginning 2940' from DER, 79' right of centerline, up to 100' AGL/1558' MSL.

Towers beginning 1.8 NM from DER, 2962' right of centerline, up to 221' AGL/1721' MSL.

Top of REIL 10' from DER, 89' right of centerline, 1' AGL/1168' MSL.

Trees beginning 5205' from DER, 78' left of centerline, up to 100' AGL/1428' MSL.

**Rwy 27**, trees beginning 114' from DER, 4' right of centerline, up to 100' AGL/1416' MSL.

Poles beginning 3068' from DER, 141' right of centerline, up to 100' AGL/1420' MSL.

TL tower 7681' from DER, 1652' right of centerline, 92' AGL/1422' MSL.

Ground beginning 451' from DER, 11' right of centerline, 1326' MSL.

Ground beginning 1159' from DER, 19' left of centerline, 1340' MSL.

Vehicle on road 1.3 NM from DER, crossing centerline, up to 15' AGL/1317' MSL.

Vehicle on road beginning 1' from DER, 170' right of centerline, up to 15' AGL/1199' MSL.

Buildings beginning 3163' from DER, 41' right of centerline, up to 40' AGL/1320' MSL.

Light support structures beginning 3112' from DER, 129' right of centerline, up to 7' AGL/1307' MSL.

Fences beginning 3243' from DER, 229' right of centerline, 7' AGL/1310' MSL.

Trees beginning 8' from DER, 2' left of centerline, up to 100' AGL/1420' MSL.

Poles beginning 3274' from DER, 363' left of centerline, up to 34' AGL/1414' MSL.

Vehicle on road 1.3 NM from DER, crossing centerline, up to 15' AGL/1317' MSL.

Buildings beginning 3092' from DER, 255' left of centerline, up to 23' AGL/1380' MSL.

Light support structures 3474' from DER, 736' left of centerline, 17' AGL/1317' MSL.

Fence beginning 3226' from DER, 220' left of centerline up to 25' AGL/1296' MSL.

## WAYNESBURG, PA

### GREENE COUNTY (WAY)

#### TAKEOFF MINIMUMS AND (OBSTACLE) DEPARTURE PROCEDURES

ORIG 25SEP08 (08269) (FAA)

##### TAKEOFF MINIMUMS:

**Rwy 9**, NA-obstacle.

**Rwy 27**, 300-1 or Std. w/ min. climb of 447' per NM to 1300.

##### DEPARTURE PROCEDURE:

**Rwy 27**, climb heading 268° to 1800 before proceeding on course.

##### TAKEOFF OBSTACLE NOTES:

**Rwy 27**, trees beginning 332' from DER, 315' left of centerline, up to 100' AGL/1119' MSL.

Trees beginning 332' from DER, 360' right of centerline, up to 100' AGL/1239' MSL.

Pole/sign 1672' from DER, 623' left of centerline, 80' AGL/1148' MSL.

# TAKEOFF MINIMUMS, (OBSTACLE) DEPARTURE PROCEDURES, AND DIVERSE VECTOR AREA (RADAR VECTORS)

23334

# TAKEOFF MINIMUMS, (OBSTACLE) DEPARTURE PROCEDURES, AND DIVERSE VECTOR AREA (RADAR VECTORS)

23334

## WELLSBORO, PA

### GRAND CANYON RGNL (N38)

#### TAKEOFF MINIMUMS AND (OBSTACLE) DEPARTURE PROCEDURES

AMDT 3B 08SEP22 (22251) (FAA)

##### TAKEOFF MINIMUMS:

**Rwy 28**, std. w/min. climb of 265' per NM to 2500.

**Rwys 11, 29**, NA-Environmental.

##### DEPARTURE PROCEDURE:

**Rwy 10**, climbing right turn direct SFK VOR/DME, thence...

**Rwy 28**, climb heading 279° to 2600, then climbing left turn direct SFK VOR/DME, thence...

...climb in SFK VOR/DME holding pattern (SW, right turns, 036° inbound) to cross SFK VOR/DME at or above 4000 before proceeding on course.

##### TAKEOFF OBSTACLE NOTES:

**Rwy 10**, building 32' from DER, 485' right of centerline, 22' AGL/1903' MSL.

Pole 33' from DER, 353' right of centerline, 22' AGL/1904' MSL.

Pole 149' from DER, 352' right of centerline, 25' AGL/1906' MSL.

Building and vehicles on road beginning 178' from DER, 174' right of centerline, up to 32' AGL/1917' MSL.

Buildings and vehicles on road beginning 307' from DER, 47' right of centerline, up to 16' AGL/1922' MSL.

Vehicles on road 420' from DER, 590' right of centerline, 1927' MSL.

Tree, vehicles on road, beginning 448' from DER, 185' right of centerline, up to 1972' MSL.

Trees, poles, vehicles on road and terrain beginning 535' from DER, 191' right of centerline, up to 1979' MSL.

Trees beginning 2959' from DER, 237' right of centerline, up to 1982' MSL.

Tree 3708' from DER, 470' right of centerline, 1987' MSL.

Tree 237' from DER, 381' left of centerline, 1902' MSL.

Tree 329' from DER, 425' left of centerline, 1914' MSL.

Trees beginning 440' from DER, 329' left of centerline, up to 1927' MSL.

Trees beginning 832' from DER, 294' left of centerline, up to 1929' MSL.

Trees beginning 1037' from DER, 362' left of centerline, up to 1930' MSL.

Tree 1417' from DER, 555' left of centerline, 1931' MSL.

Tree 1424' from DER, 420' left of centerline, 1933' MSL.

**Rwy 28**, tree and terrain beginning 56' from DER, 342' left of centerline, up to 1962' MSL.

Multiple trees beginning 289' from DER, 286' left of centerline, up to 1967' MSL.

Tree 2.2 NM from DER, 1934' right of centerline, 100' AGL/2339' MSL.

## WEST CHESTER, PA

### BRANDYWINE RGNL (OQN)

#### TAKEOFF MINIMUMS AND (OBSTACLE) DEPARTURE PROCEDURES

AMDT 2 20JUN19 (19171) (FAA)

##### TAKEOFF MINIMUMS:

**Rwy 27**, 300-1 or std. w/min. climb of 393' per NM to 700.

##### TAKEOFF OBSTACLE NOTES:

**Rwy 9**, pole 9' from DER, 24' left of centerline, 3' AGL/463' MSL.

Poles beginning 10' from DER, 13' right of centerline, up to 3' AGL/463' MSL.

Tree, pole beginning 65' from DER, 96' left of centerline, up to 39' AGL/502' MSL.

Tree 272' from DER, 49' right of centerline, 39' AGL/471' MSL.

Tree 1404' from DER, 211' left of centerline, 65' AGL/505' MSL.

Tree 1427' from DER, 707' left of centerline, 105' AGL/545' MSL.

Trees beginning 1507' from DER, 56' left of centerline, up to 114' AGL/546' MSL.

Tree 2271' from DER, 208' right of centerline, 116' AGL/523' MSL.

Tree 2415' from DER, 246' right of centerline, 124' AGL/535' MSL.

**Rwy 27**, pole 7' from DER, 24' left of centerline, 3' AGL/455' MSL.

Poles beginning 8' from DER, 5' right of centerline, up to 3' AGL/455' MSL.

Trees beginning 50' from DER, 103' right of centerline, up to 37' AGL/471' MSL.

Tree, pole beginning 140' from DER, 38' right of centerline, up to 81' AGL/530' MSL.

Tree 313' from DER, 134' left of centerline, 43' AGL/468' MSL.

Tree, building beginning 690' from DER, 157' left of centerline, up to 53' AGL/486' MSL.

Trees beginning 997' from DER, 69' left of centerline, up to 39' AGL/487' MSL.

Tree 1043' from DER, 184' left of centerline, 39' AGL/490' MSL.

Tree, pole, building beginning 1132' from DER, 3' left of centerline, up to 42' AGL/496' MSL.

Tree 1647' from DER, 156' left of centerline, 32' AGL/499' MSL.

Pole 1704' from DER, 168' left of centerline, 37' AGL/504' MSL.

Tree, pole beginning 1741' from DER, 2' left of centerline, up to 64' AGL/531' MSL.

Tree 1790' from DER, 154' left of centerline, 70' AGL/534' MSL.

Tree 1891' from DER, 44' left of centerline, 86' AGL/540' MSL.

Trees beginning 2037' from DER, 217' right of centerline, up to 78' AGL/532' MSL.

Tree 2051' from DER, 202' left of centerline, 92' AGL/552' MSL.

Trees beginning 2248' from DER, 157' left of centerline, up to 109' AGL/568' MSL.

Tree 2740' from DER, 351' right of centerline, 60' AGL/534' MSL.

Trees beginning 2929' from DER, 11' right of centerline, up to 86' AGL/551' MSL.

Tree 3205' from DER, 413' right of centerline, 100' AGL/597' MSL.

Trees beginning 3368' from DER, 315' right of centerline, up to 104' AGL/614' MSL.

Tree 3455' from DER, 389' right of centerline, 122' AGL/623' MSL.

Trees beginning 3517' from DER, 84' right of centerline, up to 120' AGL/618' MSL.

# TAKEOFF MINIMUMS, (OBSTACLE) DEPARTURE PROCEDURES, AND DIVERSE VECTOR AREA (RADAR VECTORS)

23334

NE-4

# TAKEOFF MINIMUMS, (OBSTACLE) DEPARTURE PROCEDURES, AND DIVERSE VECTOR AREA (RADAR VECTORS)

23334

## WHEELING, WV

### WHEELING OHIO COUNTY (HLG)

#### TAKEOFF MINIMUMS AND (OBSTACLE) DEPARTURE PROCEDURES

AMDT 3A 31MAR16 (16091) (FAA)

#### TAKEOFF OBSTACLE NOTES:

**Rwy 3**, tree 95' from DER, 315' right of centerline, 13' AGL/1213' MSL.

Tree 351' from DER, 264' left of centerline, 48' AGL/1227' MSL.

Obstruction light on antenna 96' from DER, 240' left of centerline, 9' AGL/1208' MSL.

Obstruction light on transmission tower 5596' from DER, 1128' right of centerline, 100' AGL/1341' MSL.

**Rwy 16**, pole 125' from DER, 241' left of centerline, 4' AGL/1203' MSL.

Pole 264' from DER, 261' right of centerline, 6' AGL/1205' MSL.

Post 267' from DER, 242' left of centerline, 19' AGL/1198' MSL.

Tree 299' from DER, 273' left of centerline, 46' AGL/1225' MSL.

**Rwy 21**, tree 9' from DER, 459' right of centerline, 39' AGL/1176' MSL.

Tree 69' from DER, 455' right of centerline, 39' AGL/1179' MSL.

Tree 69' from DER, 406' right of centerline, 40' AGL/1190' MSL.

Multiple trees beginning 77' from DER, 367' right of centerline, up to 37' AGL/1194' MSL.

**Rwy 34**, multiple trees beginning 460' from DER, 402' right of centerline, up to 46' AGL/1225' MSL.

Obstruction light on antenna 436' from DER, 599' left of centerline, 45' AGL/1224' MSL.

## WILKES-BARRE/SCRANTON, PA

### WILKES-BARRE/SCRANTON INTL (AVP)

#### TAKEOFF MINIMUMS AND (OBSTACLE) DEPARTURE PROCEDURES

AMDT 3 17OCT13 (13290) (FAA)

#### TAKEOFF MINIMUMS:

**Rwy 10**, NA-obstacles.

**Rwy 4**, 300-1 $\frac{1}{4}$  w/min. climb of 210' per NM to 2800 or std. w/min. climb of 220' per NM to 1800 or 2000-3 for climb in visual conditions.

**Rwy 22**, 500-3 w/min. climb of 240' per NM to 1800 or std. w/min. climb of 290' per NM to 1800 or 2000-3 for climb in visual conditions.

#### DEPARTURE PROCEDURE:

**Rwy 4**, climb heading 044° to 2800 before proceeding on course. For climb in visual conditions: cross Wilkes-Barre/Scranton Intl airport at or above 2800 MSL before proceeding on course. When executing VCOA, notify ATC prior to departure.

**Rwy 22**, climb heading 224° to 1400, then climbing right turn on heading 250° and LVZ VORTAC R-287 to 3000 before proceeding on course. For climb in visual conditions: cross Wilkes-Barre/Scranton Intl airport at or above 2800 MSL before proceeding on course. When executing VCOA, notify ATC prior to departure.

**Rwy 28**, climbing left turn on heading 250° and LVZ VORTAC R-287 to 3000 before proceeding on course.

#### TAKEOFF OBSTACLE NOTES:

**Rwy 4**, trees 5847' from DER, 1632' left of centerline, up to 91' AGL/1070' MSL.

**Rwy 22**, trees 1.4 NM from DER, 2576' left of centerline, up to 100' AGL/1279' MSL.

Trees 2.4 NM from DER, 3790' left of centerline, up to 100' AGL/1419' MSL.

## WILKES-BARRE WYOMING VALLEY (WBW)

#### TAKEOFF MINIMUMS AND (OBSTACLE) DEPARTURE PROCEDURES

ORIG 26JUL12 (12208) (FAA)

#### TAKEOFF MINIMUMS:

**Rwy 7**, std. w/min. climb of 280' per NM to 3300, or 2400-3 for climb in visual conditions.

**Rwy 9**, std. w/min. climb of 307' per NM to 2600, or 2400-3 for climb in visual conditions.

**Rwy 25**, std. w/min. climb of 320' per NM to 3100, or 2400-3 for climb in visual conditions.

**Rwy 27**, 1000-3 w/min. climb of 415' per NM to 2200, or 2400-3 for climb in visual conditions.

#### DEPARTURE PROCEDURE:

**Rwy 7**, climb heading 066° to 3300 before proceeding on course or for climb in visual conditions cross Wilkes-Barre Wyoming Valley airport at or above 2800 before proceeding on course.

**Rwy 9**, climb heading 089° to 2800 before proceeding on course or for climb in visual conditions cross Wilkes-Barre Wyoming Valley airport at or above 2800 before proceeding on course.

**Rwy 25**, climb heading 246° to 3100 before proceeding on course or for climb in visual conditions cross Wilkes-Barre Wyoming Valley airport at or above 2800 before proceeding on course.

**Rwy 27**, climb heading 269° to 2700 before proceeding on course or for climb in visual conditions cross Wilkes-Barre Wyoming Valley airport at or above 2800 before proceeding on course.

#### TAKEOFF OBSTACLE NOTES:

**Rwy 7**, road beginning 182' from DER, 428' right of centerline, up to 15' AGL/579' MSL.

Trees and poles beginning 409' from DER, 32' left of centerline, up to 99' AGL/659' MSL.

Trees and poles beginning 639' from DER, 309' right of centerline, up to 100' AGL/699' MSL.

Dike 751' from DER, right and left of centerline, 0' AGL/564' MSL.

Building 3071' from DER, 873' left of centerline, up to 80' AGL/640' MSL.

Mobile crane 4526' from DER, up to 120' AGL/660' MSL.

High tension power pole 6003' from DER, 1843' right of centerline, up to 173' AGL/719' MSL.

**Rwy 9**, trees beginning 39' from DER, 47' right of centerline, up to 111' AGL/651' MSL.

Trees beginning 104' from DER, 344' left of centerline, up to 100' AGL/640' MSL.

Buildings beginning 1.44 NM from DER, 2517' right of centerline, up to 58' AGL/918' MSL.

CON'T

22 FEB 2024 to 21 MAR 2024

22 FEB 2024 to 21 MAR 2024

# TAKEOFF MINIMUMS, (OBSTACLE) DEPARTURE PROCEDURES, AND DIVERSE VECTOR AREA (RADAR VECTORS)

23334

NE-4

# TAKEOFF MINIMUMS, (OBSTACLE) DEPARTURE PROCEDURES, AND DIVERSE VECTOR AREA (RADAR VECTORS)

23334

## WILKES-BARRE/SCRANTON, PA (CON'T)

### WILKES-BARRE WYOMING VALLEY (WBW) (CON'T)

- Rwy 25**, road beginning 17' from DER, 435' left of centerline, up to 15' AGL/577' MSL.  
Trees beginning 553' from DER, 103' left of centerline, up 134' AGL/634' MSL.  
Trees beginning 1668' from DER, 36' right of centerline, up to 107' AGL/647' MSL.  
Tower 1.23 NM from DER, 1297' right of centerline, 203' AGL/753' MSL.
- Rwy 27**, trees 539' from DER, 380' left of centerline, up to 117' AGL/557' MSL.  
Trees beginning 1285' from DER, left and right of centerline, up to 107' AGL/647' MSL.  
Poles and trees beginning 1.18 NM from DER, 957' right of centerline, up to 52' AGL/1352' MSL.

## WILLIAMSON, WV

### SOUTHERN WEST VIRGINIA RGNL (EBD)

#### TAKEOFF MINIMUMS AND (OBSTACLE) DEPARTURE PROCEDURES

ORIG-A 26JUL12 (22307) (FAA)

#### TAKEOFF MINIMUMS:

**Rwy 8**, 500-2'.**Rwy 26**, 300-2.

NOTE: NA at night.

#### DEPARTURE PROCEDURE:

- Rwy 8**, climb heading 077° to 2700 before proceeding on course.  
**Rwy 26**, climb heading 257° to 2400 before proceeding on course.

#### TAKEOFF OBSTACLE NOTES:

- Rwy 8**, trees and high terrain beginning at DER, 77' right of centerline, up to 100' AGL/1998' MSL.  
Trees beginning 347' from DER, 185' left of centerline, up to 100' AGL/1998' MSL.  
**Rwy 26**, trees beginning 11' from DER, 35' left of centerline, up to 100' AGL/1927' MSL.  
Trees beginning 864' from DER, 79' right of centerline, up to 100' AGL/1998' MSL.

## WILLIAMSPORT, PA

### WILLIAMSPORT RGNL (IPT)

#### TAKEOFF MINIMUMS AND (OBSTACLE) DEPARTURE PROCEDURES

AMDT 6 22JUN17 (17173) (FAA)

#### TAKEOFF MINIMUMS:

- Rwy 9**, std. w/min. climb of 300' per NM to 1500 or 2800-3 VCOA.  
**Rwy 12**, std. w/min. climb of 475' per NM to 1000 or 2800-3 VCOA.  
**Rwy 27**, std. w/min. climb of 470' per NM to 1000 or 2800-3 VCOA.  
**Rwy 30**, std. w/min. climb of 375' per NM to 1500 or 2800-3 VCOA.

#### DEPARTURE PROCEDURE:

- Rwy 9**, climb heading 087° to 2600 before proceeding on course.  
**Rwy 12**, climbing left turn heading 090° to 2500 before proceeding on course.  
**Rwy 27**, climbing right turn heading 285° to 2800 before proceeding on course.  
**Rwy 30**, climb heading 296° to 2500 before proceeding on course.

#### VCOA:

**All Rwys**, Obtain ATC approval for VCOA when requesting IFR clearance. Climb in visual conditions to cross Williamsport RGNL Airport at or above 2800 before proceeding on course.

#### TAKEOFF OBSTACLE NOTES:

- Rwy 9**, fence, light pole, ALS, twy sign beginning 4' from DER, 4' left of centerline, up to 10' AGL/536' MSL.  
Light pole, ALS beginning 5' from DER, 5' right of centerline, up to 1' AGL/526' MSL.  
Railroad, fence, tree beginning 170' from DER, 331' left of centerline, up to 552' MSL.  
Tree, fence beginning 240' from DER, 290' right of centerline, up to 537' MSL.  
T-L tower, tree, bush, pole beginning 359' from DER, 265' left of centerline, up to 40' AGL/566' MSL.  
Gen util, ALS beginning 398' from DER, 0' of centerline, up to 23' AGL/540' MSL.  
Building, railroad, pole, light pole, tree, ALS, gen util beginning 616' from DER, 0' left of centerline, up to 47' AGL/576' MSL.  
Gen util, tree beginning 620' from DER, 0' of centerline, up to 40' AGL/558' MSL.  
Light pole 1175' from DER, 28' right of centerline, 30' AGL/560' MSL.  
Pole 1521' from DER, 309' right of centerline, 45' AGL/564' MSL.  
Tree 1523' from DER, 871' right of centerline, 574' MSL.  
Tree 2278' from DER, 66' left of centerline, 587' MSL.  
Tree 2290' from DER, 155' left of centerline, 590' MSL.  
Tree 3013' from DER, 372' left of centerline, 61' AGL/606' MSL.  
Trees beginning 3317' from DER, 413' left of centerline, up to 46' AGL/616' MSL.  
Tree 3364' from DER, 801' left of centerline, 47' AGL/619' MSL.  
Tree 3397' from DER, 909' left of centerline, 42' AGL/626' MSL.  
Trees beginning 3414' from DER, 433' left of centerline, up to 60' AGL/642' MSL.  
Tree 3527' from DER, 382' right of centerline, 87' AGL/617' MSL.  
Trees beginning 4991' from DER, 430' left of centerline, up to 654' MSL.  
Tree 5003' from DER, 500' left of centerline, 658' MSL.  
Tree 5078' from DER, 1058' right of centerline, 95' AGL/669' MSL.  
Tree 5236' from DER, 1115' right of centerline, 89' AGL/677' MSL.  
Trees beginning 5280' from DER, 1067' right of centerline, up to 104' AGL/686' MSL.  
Trees beginning 5438' from DER, 1157' right of centerline, up to 102' AGL/694' MSL.  
Tree 5966' from DER, 1722' right of centerline, 740' MSL.  
Tree, tower beginning 6072' from DER, 1608' right of centerline, up to 744' MSL.  
Trees beginning 6072' from DER, 1553' right of centerline, up to 104' AGL/744' MSL.

CON'T

# TAKEOFF MINIMUMS, (OBSTACLE) DEPARTURE PROCEDURES, AND DIVERSE VECTOR AREA (RADAR VECTORS)

23334

# TAKEOFF MINIMUMS, (OBSTACLE) DEPARTURE PROCEDURES, AND DIVERSE VECTOR AREA (RADAR VECTORS)

23334

## WILLIAMSPORT, PA (CON'T)

### WILLIAMSPORT RGNL (IPT) (CON'T)

**Rwy 9 (CON'T)**, tree 6072' from DER, 1620' right of centerline, 98' AGL/742' MSL.

Tree 1 NM from DER, 1228' left of centerline, 83' AGL/711' MSL.

Tree 1.1 NM from DER, 1323' left of centerline, 101' AGL/745' MSL.

Trees beginning 1.1 NM from DER, 1164' left of centerline, up to 755' MSL.

Tree 1.1 NM from DER, 1476' left of centerline, 757' MSL.

Tree, tower beginning 1.1 NM from DER, 1036' left of centerline, up to 759' MSL.

Tree 1.2 NM from DER, 1416' left of centerline, 84' AGL/760' MSL.

Tree 1.3 NM from DER, 1357' left of centerline, 95' AGL/761' MSL.

Trees beginning 1.3 NM from DER, 1208' right of centerline, up to 90' AGL/771' MSL.

Tree 1.3 NM from DER, 1399' right of centerline, 99' AGL/767' MSL.

Tree 1.3 NM from DER, 1470' right of centerline, 93' AGL/775' MSL.

Tree 1.3 NM from DER, 1538' left of centerline, 105' AGL/767' MSL.

Tree 1.3 NM from DER, 1387' left of centerline, 92' AGL/773' MSL.

Tree, tower beginning 1.4 NM from DER, 1251' right of centerline, up to 781' MSL.

Tree 1.4 NM from DER, 1377' left of centerline, 88' AGL/777' MSL.

Tree 1.4 NM from DER, 1247' left of centerline, 91' AGL/784' MSL.

Tree 1.4 NM from DER, 1225' left of centerline, 90' AGL/788' MSL.

Tree 1.4 NM from DER, 1220' left of centerline, 788' MSL.

**Rwy 12**, tree 12' from DER, 369' right of centerline, 536' MSL.

ALS 284' from DER, 499' left of centerline, 17' AGL/539' MSL.

Gen util 285' from DER, 498' left of centerline, 23' AGL/540' MSL.

Trees beginning 324' from DER, 3' right of centerline, up to 553' MSL.

Trees beginning 413' from DER, 19' right of centerline, up to 39' AGL/561' MSL.

Gen util 478' from DER, 608' left of centerline, 40' AGL/558' MSL.

Tree 1172' from DER, 65' left of centerline, 566' MSL.

Tree, pole beginning 1336' from DER, 97' left of centerline, up to 568' MSL.

Tree 1690' from DER, 283' left of centerline, 574' MSL.

Tree 1933' from DER, 263' left of centerline, 576' MSL.

Tree 2686' from DER, 191' left of centerline, 600' MSL.

Tree 2739' from DER, 90' right of centerline, 596' MSL.

Trees beginning 2770' from DER, 87' left of centerline, up to 611' MSL.

Tree 5134' from DER, 1840' left of centerline, 87' AGL/676' MSL.

Tree 5596' from DER, 1885' left of centerline, 94' AGL/689' MSL.

Trees beginning 6019' from DER, 1596' left of centerline, up to 740' MSL.

Tree 6072' from DER, 1736' left of centerline, 98' AGL/742' MSL.

Tree, tower beginning 6072' from DER, 1673' left of centerline, up to 744' MSL.

Pole beginning 1.5 NM from DER, 2216' right of centerline, up to 50' AGL/813' MSL.

**Rwy 27**, ground, ALS beginning 7' from DER, 55' left of centerline, up to 515' MSL.

ALS beginning 9' from DER, 55' right of centerline, up to 2' AGL/515' MSL.

NAVAid 437' from DER, 0' of centerline, 17' AGL/525' MSL.

Building beginning 517' from DER, 305' right of centerline, up to 16' AGL/533' MSL.

Building 531' from DER, 302' right of centerline, 21' AGL/537' MSL.

Tower 543' from DER, 292' right of centerline, 22' AGL/540' MSL.

Tree 669' from DER, 467' left of centerline, 25' AGL/533' MSL.

Trees beginning 1954' from DER, 22' left of centerline, up to 599' MSL.

Tree 2050' from DER, 46' right of centerline, 86' AGL/599' MSL.

Trees beginning 2128' from DER, 96' right of centerline, up to 602' MSL.

Trees beginning 2154' from DER, 49' left of centerline, up to 601' MSL.

Trees beginning 2304' from DER, 23' left of centerline, up to 604' MSL.

Tree 3309' from DER, 133' left of centerline, 97' AGL/608' MSL.

Trees beginning 3312' from DER, 47' left of centerline, up to 611' MSL.

Tree 3455' from DER, 28' right of centerline, 616' MSL.

Tree 3565' from DER, 371' left of centerline, 95' AGL/613' MSL.

Trees beginning 3566' from DER, 152' left of centerline, up to 614' MSL.

Tree 4522' from DER, 352' left of centerline, 627' MSL.

Trees beginning 4557' from DER, 490' left of centerline, up to 647' MSL.

Trees beginning 4748' from DER, 384' left of centerline, up to 86' AGL/649' MSL.

Tree 4749' from DER, 494' left of centerline, 659' MSL.

Trees beginning 4753' from DER, 197' left of centerline, up to 86' AGL/661' MSL.

Trees beginning 4963' from DER, 478' left of centerline, up to 672' MSL.

Trees beginning 5068' from DER, 417' left of centerline, up to 91' AGL/675' MSL.

Trees beginning 5068' from DER, 354' left of centerline, up to 91' AGL/675' MSL.

Trees beginning 5068' from DER, 164' left of centerline, up to 678' MSL.

Trees beginning 5280' from DER, 96' left of centerline, up to 686' MSL.

Trees beginning 5596' from DER, 378' left of centerline, up to 706' MSL.

Tower, T-L tower beginning 1.6 NM from DER, 1923' left of centerline, up to 88' AGL/940' MSL.

T-L tower 2.1 NM from DER, 1893' left of centerline, 94' AGL/1040' MSL.

Pole 2.1 NM from DER, 3626' left of centerline, up to 103' AGL/1572' MSL.

**CON'T**

22 FEB 2024 to 21 MAR 2024

22 FEB 2024 to 21 MAR 2024

# TAKEOFF MINIMUMS, (OBSTACLE) DEPARTURE PROCEDURES, AND DIVERSE VECTOR AREA (RADAR VECTORS)

23334

NE-4

# TAKEOFF MINIMUMS, (OBSTACLE) DEPARTURE PROCEDURES, AND DIVERSE VECTOR AREA (RADAR VECTORS)

23334

## WILLIAMSPORT, PA (CON'T)

### WILLIAMSPORT RGNL (IPT) (CON'T)

**Rwy 30**, fence 98' from DER, 348' left of centerline, 8' AGL/531' MSL.  
 Road 210' from DER, 12' left of centerline, 539' MSL.  
 Road, sign beginning 256' from DER, 108' right of centerline, up to 537' MSL.  
 Pole 428' from DER, 494' right of centerline, 69' AGL/588' MSL.  
 Tree 1643' from DER, 177' right of centerline, 600' MSL.  
 Tree 1696' from DER, 290' right of centerline, 608' MSL.  
 Trees beginning 1789' from DER, 177' right of centerline, up to 614' MSL.  
 Tree 1847' from DER, 284' left of centerline, 582' MSL.  
 Trees beginning 1946' from DER, 139' left of centerline, up to 597' MSL.  
 Trees beginning 2030' from DER, 265' left of centerline, up to 602' MSL.  
 Tree 2194' from DER, 182' left of centerline, 614' MSL.  
 Tree, T-L tower, pole beginning 2217' from DER, 17' right of centerline, up to 617' MSL.  
 Trees beginning 2462' from DER, 92' left of centerline, up to 628' MSL.  
 Trees beginning 2822' from DER, 14' left of centerline, up to 629' MSL.  
 Trees beginning 2981' from DER, 27' right of centerline, up to 619' MSL.  
 Trees beginning 3172' from DER, 20' right of centerline, up to 623' MSL.  
 Tree 3731' from DER, 450' left of centerline, 630' MSL.  
 Tree 3746' from DER, 29' right of centerline, 628' MSL.  
 Tree 3839' from DER, 118' left of centerline, 638' MSL.  
 Trees beginning 3845' from DER, 18' left of centerline, up to 640' MSL.  
 Tree, pole beginning 4277' from DER, 327' right of centerline, up to 645' MSL.  
 Pole 4465' from DER, 225' right of centerline, 37' AGL/647' MSL.  
 Tree, pole beginning 4488' from DER, 12' right of centerline, up to 700' MSL.  
 Tree, pole beginning 4646' from DER, 49' right of centerline, up to 701' MSL.  
 Tree 4699' from DER, 37' left of centerline, 695' MSL.  
 Tree, bush beginning 4752' from DER, 138' right of centerline, up to 737' MSL.  
 Tree, pole beginning 4804' from DER, 33' left of centerline, up to 706' MSL.  
 Tree, pole beginning 5016' from DER, 29' left of centerline, up to 707' MSL.  
 Tree 5016' from DER, 96' right of centerline, 754' MSL.  
 Pole, ground, tree beginning 5016' from DER, 27' right of centerline, up to 53' AGL/755' MSL.  
 Tree, pole beginning 5068' from DER, 132' left of centerline, up to 731' MSL.  
 Tree, pole beginning 5227' from DER, 96' left of centerline, up to 748' MSL.  
 Trees beginning 5385' from DER, 31' right of centerline, up to 764' MSL.  
 Trees beginning 5438' from DER, 82' left of centerline, up to 771' MSL.  
 Trees beginning 5544' from DER, 127' left of centerline, up to 777' MSL.

## YORK, PA

### YORK (THV)

#### TAKEOFF MINIMUMS AND (OBSTACLE) DEPARTURE PROCEDURES

AMDT 1 13JAN11 (11013) (FAA)

##### TAKEOFF MINIMUMS:

**Rwy 17**, 300-1¼ or std. w/ min. climb of 473' per NM to 800.  
**Rwy 35**, 300-1 or std. w/ min. climb of 393' per NM to 800.

##### DEPARTURE PROCEDURE:

**Rwy 17**, climb heading 166° to 1100 before turning right.

##### TAKEOFF OBSTACLE NOTES:

**Rwy 17**, terrain, catenary ball, vehicles on road, fences, poles, buildings, and trees beginning 2' from DER, 9' left of centerline, up to 46' AGL/645' MSL.  
 Terrain, vehicles on road, fences, poles, buildings, and trees beginning 38' from DER, 12' right of centerline, up to 41' AGL/645' MSL.  
 Trees 2680' from DER, 467' left of centerline, up to 54' AGL/653' MSL.  
 Trees 6013' from DER, 974' right of centerline, up to 84' AGL/713' MSL.  
 Trees 1 NM from DER, 710' right of centerline, up to 71' AGL/670' MSL.  
**Rwy 35**, terrain, building, poles, and trees beginning 32' from DER, 5' left of centerline up to 104' AGL/623' MSL.  
 Terrain, fence, building, and trees beginning 18' from DER, 8' right of centerline, up to 88' AGL/627' MSL.  
 Trees 3325' from DER, 514' right of centerline, up to 80' AGL/639' MSL.  
 Trees 3789' from DER, 1049' left of centerline, up to 101' AGL/660' MSL.  
 Trees 4121' from DER, 763' left of centerline, up to 109' AGL/628' MSL.

22 FEB 2024 to 21 MAR 2024

22 FEB 2024 to 21 MAR 2024

# TAKEOFF MINIMUMS, (OBSTACLE) DEPARTURE PROCEDURES, AND DIVERSE VECTOR AREA (RADAR VECTORS)

23334

NE-4

**TAKEOFF MINIMUMS, (OBSTACLE) DEPARTURE PROCEDURES, AND  
DIVERSE VECTOR AREA (RADAR VECTORS)**

23334

**ZELIENOPLÉ, PA**

ZELIENOPLÉ MUNI (PJC)

TAKEOFF MINIMUMS AND (OBSTACLE) DEPARTURE PROCEDURES

AMDT 3 25SEP08 (08269) (FAA)

TAKEOFF MINIMUMS:

**Rwys 17,35**, 1100-2½ for climb in visual conditions.

DEPARTURE PROCEDURE:

**Rwys 17,35**, for climb in visual conditions: cross Zeliénoplé Muni at or above 1900' before proceeding on course.

TAKEOFF OBSTACLE NOTES:

**Rwy 17**, terrain and trees beginning 1.23 NM from DER, 1272' left of centerline, up to 100' AGL/1339' MSL.

Vehicle on road beginning 18' from DER, 378' left of centerline, up to 15' AGL/946' MSL.

Brush 278' from DER, 204' left of centerline, 21' AGL/921' MSL.

Vehicle on road 451' from DER, 593' right of centerline, 15' AGL/946' MSL.

Trees beginning 2442' from DER, 1110' right of centerline, up to 100' AGL/1299' MSL.

Power lines beginning 3648' from DER, 644' right of centerline, up to 79' AGL/1046' MSL.

Trees beginning 1.27 NM from DER, 477' right of centerline, up to 100' AGL/1359' MSL.

**Rwy 35**, terrain and trees beginning 1.04 NM from DER, 1400' left of centerline, up to 100' AGL/1259' MSL.

Trees 805' from DER, 287' right of centerline, 120' AGL/1014' MSL.

Vehicle on road 161' from DER, 524' right of centerline, 15' AGL/946' MSL.

22 FEB 2024 to 21 MAR 2024

22 FEB 2024 to 21 MAR 2024

**TAKEOFF MINIMUMS, (OBSTACLE) DEPARTURE PROCEDURES, AND  
DIVERSE VECTOR AREA (RADAR VECTORS)**

23334

NE-4

HYPER EIGHT ARRIVAL (RNAV) Transition Routes  
(DELRO.HYPER8) 31DEC20

POTOMAC APP CON  
133.0 288.35  
IAD D-ATIS  
134.85  
DULLES TOWER  
120.1 317.8 (Rwy 1R/19L)  
120.25 348.6 (Rwy 1C/19C)  
134.425 348.6 (Rwy 1L/19R, 12/30)

NOTE: RADAR required.  
NOTE: RNAV 1.  
NOTE: DME/DME/IRU or GPS required.  
NOTE: Turbojet and turboprop aircraft only.  
NOTE: For aircraft capable of 180K or greater.



NOTE: Chart not to scale.

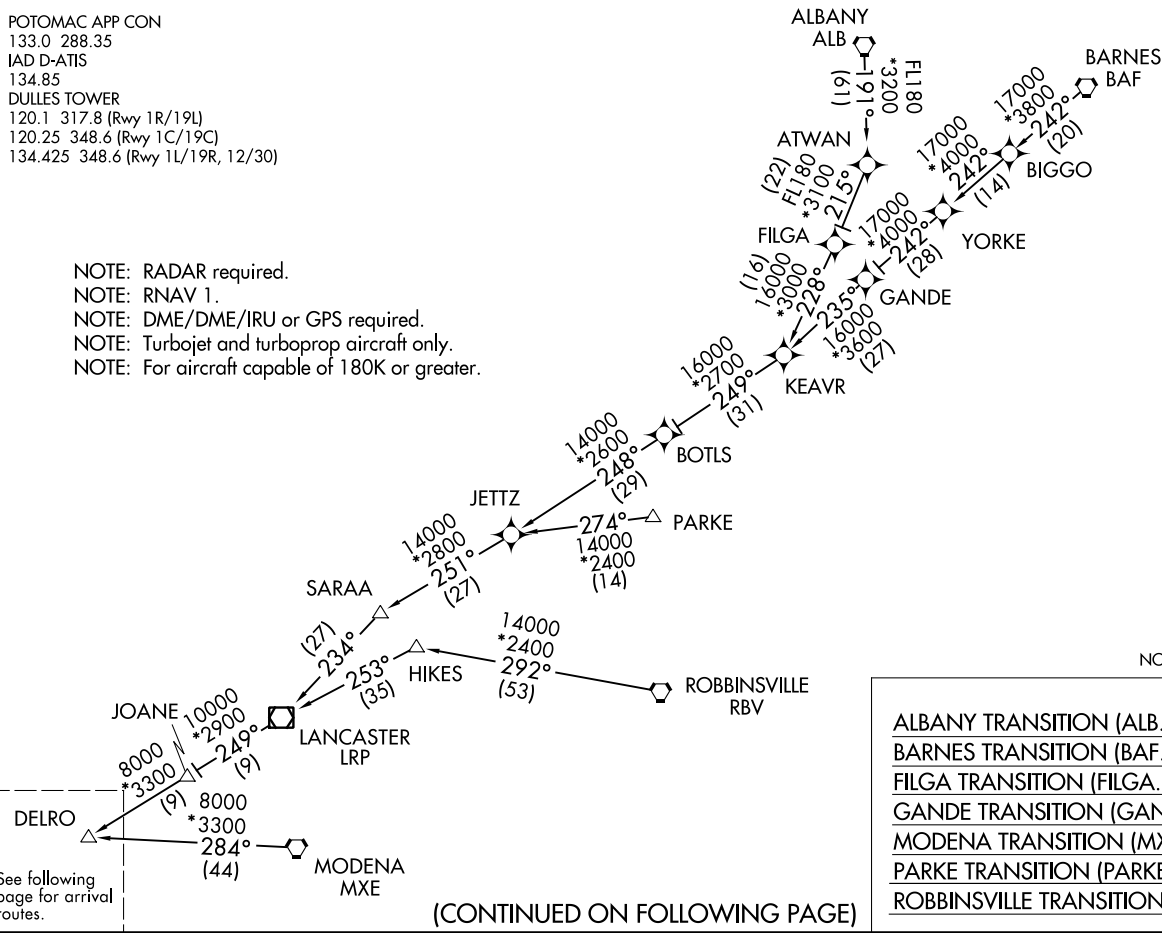

(CONTINUED ON FOLLOWING PAGE)

WASHINGTON, DC

See following page for arrival routes.

HYPER EIGHT ARRIVAL (RNAV) Transition Routes  
(AL-5100 (FAA)) 24025

WASHINGTON, DC



# HYPER EIGHT ARRIVAL (RNAV) Arrival Routes

WASHINGTON, DC

POTOMAC APP CON

133.0 288.35

IAD D-ATIS

134.85

DULLES TOWER

120.1 317.8 (Rwy 1R/19L)

120.25 348.6 (Rwy 1C/19C)

134.425 348.6 (Rwy 1L/19R, 12/30)

NOTE: RADAR required.

NOTE: RNAV 1.

NOTE: DME/DME/IRU or GPS required.

NOTE: Turbojet and turboprop aircraft only.

NOTE: For aircraft capable of 180K or greater.

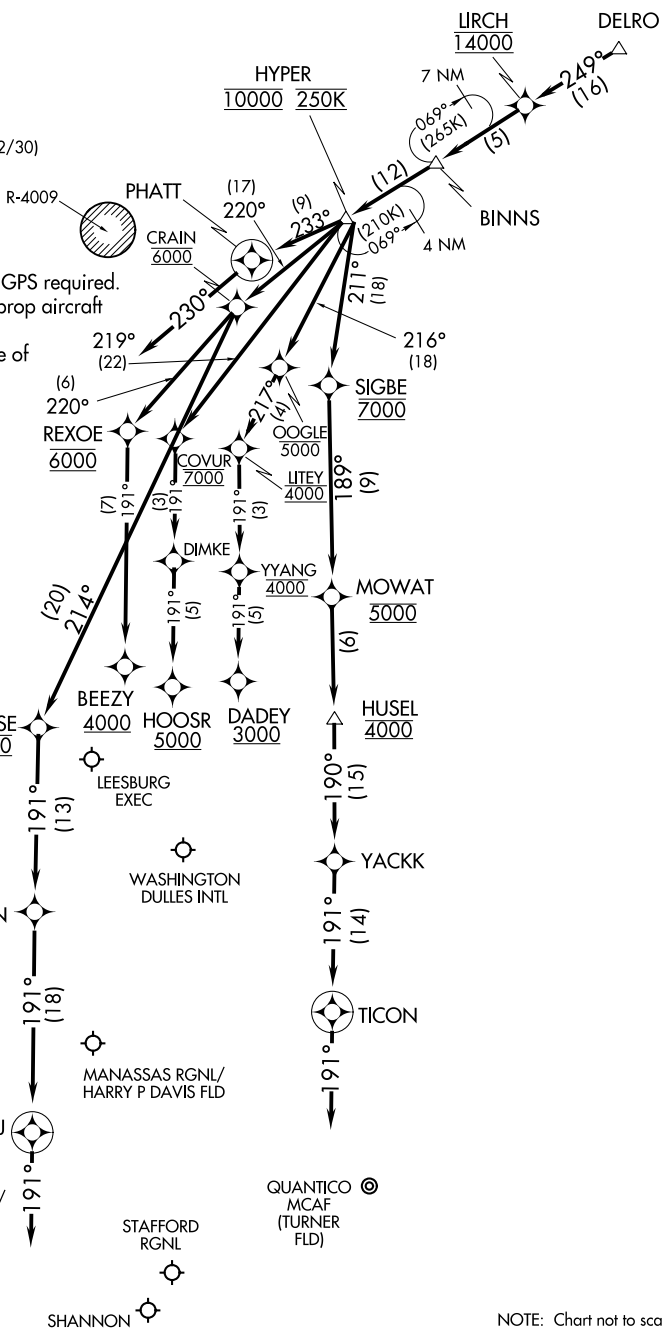

NOTE: Chart not to scale.

# HYPER EIGHT ARRIVAL (RNAV) Arrival Routes

WASHINGTON, DC

NE-3, 22 FEB 2024 to 21 MAR 2024

NE-3, 22 FEB 2024 to 21 MAR 2024

ARRIVAL ROUTE DESCRIPTION

IAD: From DELRO on track 249° to cross LIRCH at 14000, then on track 249° to BINNS, then on track 249° to cross HYPER at 10000 and at 250K.

Landing IAD Rwy 1C/R: From HYPER on track 211° to cross SIGBE at 7000, then on track 189° to cross MOWAT at 5000, then on track 189° to cross HUSEL at 4000, then on track 190° to YACKK, then on track 191° to TICON, then on track 191°. Expect RADAR vectors to final approach course.

Landing IAD Rwy 1L: From HYPER on track 220° to cross CRAIN at 6000, then on track 214° to cross KUKSE at 5000, then on track 191° to ELISN, then on track 191° to MIKEJ, then on track 191°. Expect RADAR vectors to final approach course.

Landing IAD Rwy 19C: From HYPER on track 219° to cross COVUR at 7000, then on track 191° to DIMKE, then on track 191° to cross HOOSR at or above 5000. Expect ILS or LOC Rwy 19C approach.

Landing IAD Rwy 19L: From HYPER on track 216° to cross OOGLE at or below 5000, then on track 217° to cross LITEY at 4000, then on track 191° to cross YYANG at 4000, then on track 191° to cross DADEY at or above 3000. Expect ILS or LOC Rwy 19L approach.

Landing IAD Rwy 19R: From HYPER on track 220° to cross CRAIN at 6000, then on track 220° to cross REXOE at 6000, then on track 191° to cross BEEZY at or above 4000. Expect ILS or LOC Rwy 19R approach.

Landing NYG/CJR/EZF/RMN/HWY/HEF: From DELRO on track 249° to cross LIRCH at 14000, then on track 249° to BINNS, then on track 249° to cross HYPER at 10000 and at 250K, then on track 211° to cross SIGBE at 7000, then on track 189° to cross MOWAT at 5000, then on track 189° to cross HUSEL at 4000, then on track 190° to YACKK, then on track 191° to TICON, then on track 191°. Expect RADAR vectors to final approach course.

Landing MRB/JYO/FRR/OKV: From DELRO on track 249° to cross LIRCH at 14000, then on track 249° to BINNS, then on track 249° to cross HYPER at 10000 and at 250K, then on track 233° to PHATT. Then on heading 230° or as assigned by ATC. Expect RADAR vectors to final approach course.

NE-3, 22 FEB 2024 to 21 MAR 2024

NE-3, 22 FEB 2024 to 21 MAR 2024

# PRIVO THREE ARRIVAL

POTOMAC APP CON  
 133.00 288.35  
 HEF ATIS  
 125.175  
 IAD D-ATIS  
 134.85  
 NYG ATIS ★  
 263.15

PHILIPSBURG  
 115.5 PSB  
 Chan 102

JARAF  
 Expect FL180

PRIVO

DAFIX  
 Expect 12000

OVIEE  
 Expect 10000

HAGERSTOWN  
 109.8 HGR

MAPEL  
 Expect 7000

EASTERN WV RGNL/  
 SHEPHERD FLD

LEESBURG EXEC

WASHINGTON DULLES INTL

ARMEL  
 113.5 AML  
 Chan 82

MANASSAS RGNL/  
 HARRY P DAVIS FLD

NOTE: DME and RADAR required.  
 NOTE: Jet aircraft only.

QUANTICO MCAF  
 (TURNER FLD)

(NARRATIVE ON FOLLOWING PAGE)

NOTE: Chart not to scale.

# PRIVO THREE ARRIVAL

NE-3, 22 FEB 2024 to 21 MAR 2024

NE-3, 22 FEB 2024 to 21 MAR 2024

ARRIVAL ROUTE DESCRIPTION

PHILIPSBURG TRANSITION (PSB.PRIVO3): From over PSB VORTAC on PSB R-177 to PRIVO. Thence....

....from PRIVO on PSB R-177 to DAFIX, then on PSB R-177 to OVIEE, then on AML R-358 to MAPEL. Then on HGR R-141 to TWEAK. Then on heading 190° or as assigned by ATC.

LANDING RWYS 1L/C/R and 30: Expect RADAR vectors to final approach course after TWEAK.

LANDING RWYS 19L/C/R and 12: Expect RADAR vectors to final approach course after MAPEL.

LANDING KHEF and KNYG: Expect RADAR vectors to destination airport after TWEAK.

LANDING KMRB and KJYO: Expect RADAR vectors to destination airport after MAPEL.

NE-3, 22 FEB 2024 to 21 MAR 2024

NE-3, 22 FEB 2024 to 21 MAR 2024

(TRSTN.TRSTN3) 22027

# TRSTN THREE ARRIVAL (RNAV)

AL-5326

WASHINGTON, D.C.

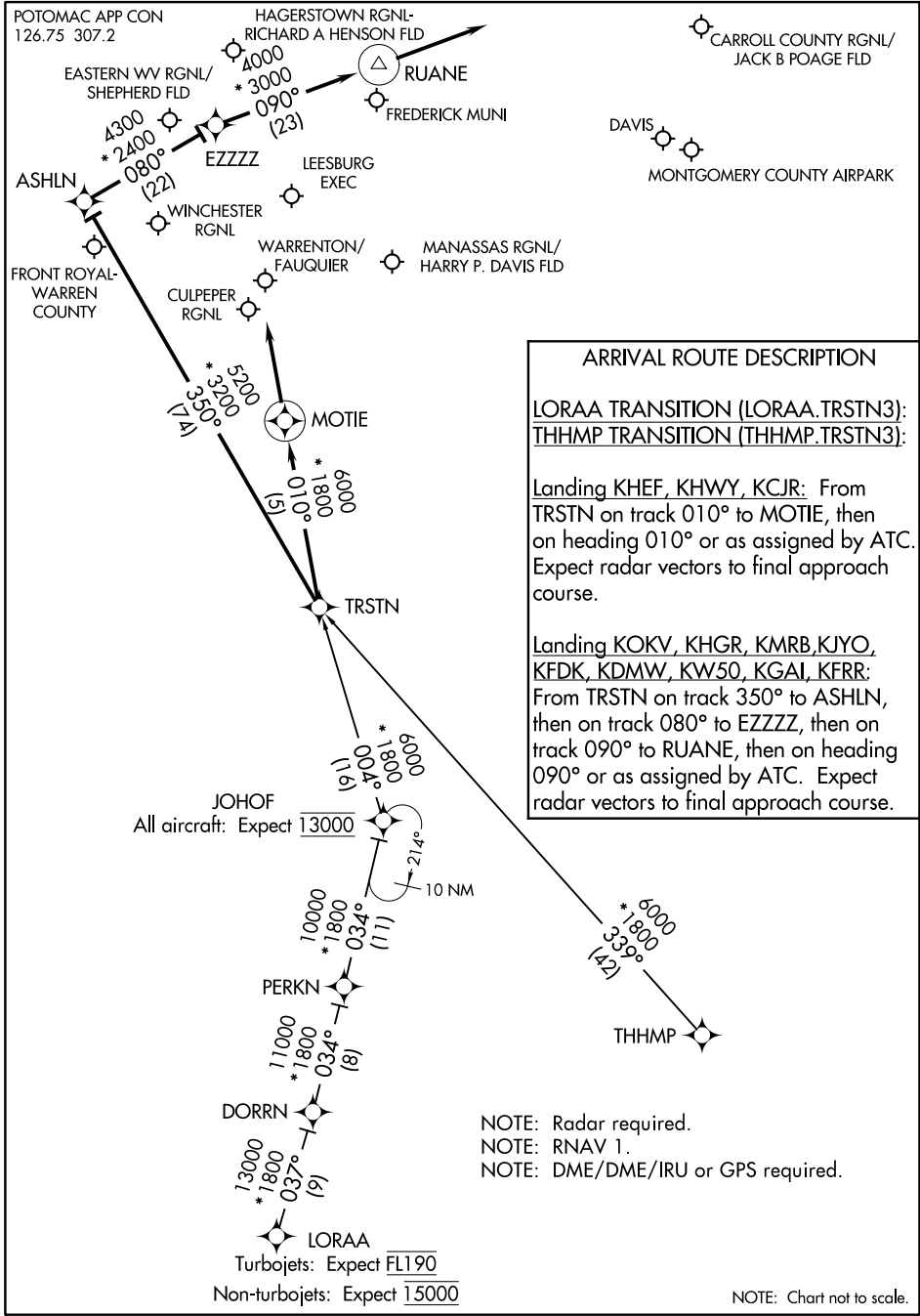

NE-3, 22 FEB 2024 to 21 MAR 2024

NE-3, 22 FEB 2024 to 21 MAR 2024

# TRSTN THREE ARRIVAL (RNAV)

(TRSTN.TRSTN3) 04FEB16

WASHINGTON, D.C.